

NAV-TV

INTERFACING THE FUTURE

3950 NW 120th Ave, Coral Springs, FL 33065 TEL 561-955-9770 FAX 561-955-9760

CHRY-RSE VIM

Video in Motion interface for 2017 Chrysler Pacifica

NTV-KIT884



BHM
07/10/18
NTV-DOC329

Overview

The CHRY-RSE VIM adds Video in Motion to the 2017+ Chrysler Pacifica. Installation is performed at the passenger side slider door area, behind the power outlet panel (CAN bank). This kit is not plug & play at this time and must be hard wired.

Kit Contents



CHRY-RSE VIM Harness
NTV-HAR128



CHRY-RSE VIM
Module



USB Cable (updates)
NTV-CAB009

CHRY-RSE VIM pin outs

Pin #	Description	Color
1	Constant 12v (+) INPUT	Yellow
2	--Not Used--	Red
3	--Not Used--	Blue
4	--Not Used--	Orange
8	CAN HI (vehicle side)	White/Blue
9	CAN HI (plug side)	White/Brown
10	Ground (-) INPUT	Black
17	CAN LO (vehicle side)	Blue
18	CAN LO (plug side)	Brown

For best reliability, *solder* all wires.

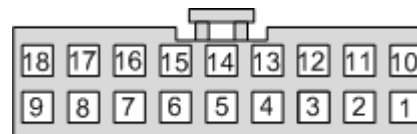

Wire side

CHRY-RSE VIM Installation

1. Installation for this module happens on the passenger side, in front of the rear wheel well. Locate the removable panel with the AC power outlet attached.



2. Remove this panel with a plastic trim tool, then disconnect the AC outlet:

3. With a pick tool, disconnect the 2nd lowest CAN plug on the middle bank (of 3 banks).

Wires: **Beige: pin 1**

White/Orange: pin 2

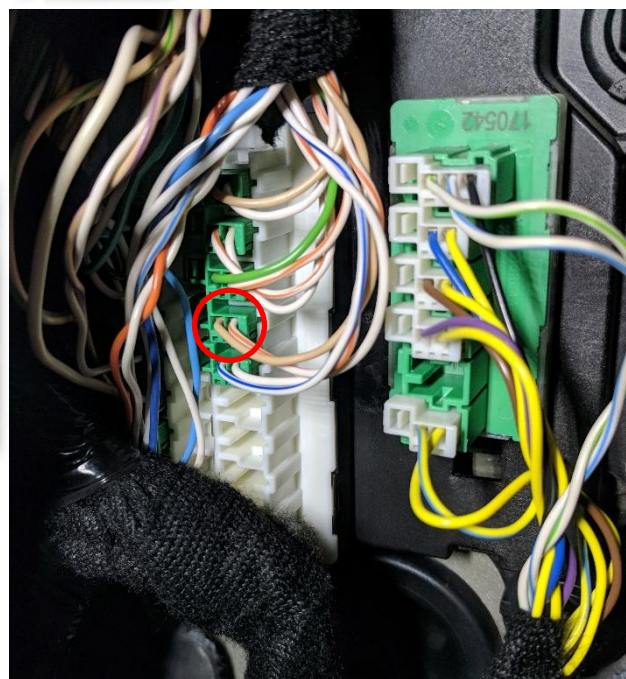
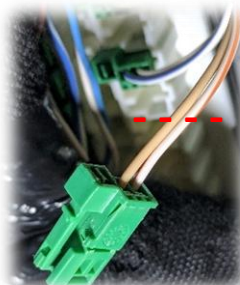

4. **With the vehicle ignition off**, cut the wires (with this plug) in half (leave slack on each side of the cut).
5. Using the provided module harness, connect (solder) the following wires to each wire on the same CAN plug from the previous steps:

Interface wire	Vehicle wire	Direction
White/Blue, PIN 8	Beige, PIN 1	Harness Side
White/Brown, PIN 9	Beige, PIN 1	Plug Side
Blue, PIN 17	White/Orange PIN 2	Harness Side
Brown, PIN 18	White/Orange, PIN 2	Plug Side

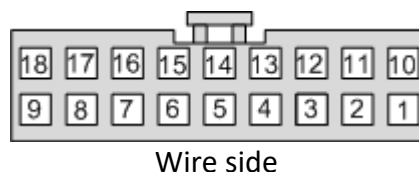

6. Connect the module's **black wire** to **Ground (-)**, connect the **yellow wire** to **Constant 12v (+)**. See images below for power location. **TEST WIRES BEFORE USING!**

Ground (-): black wire
on 3-PIN CAN plug

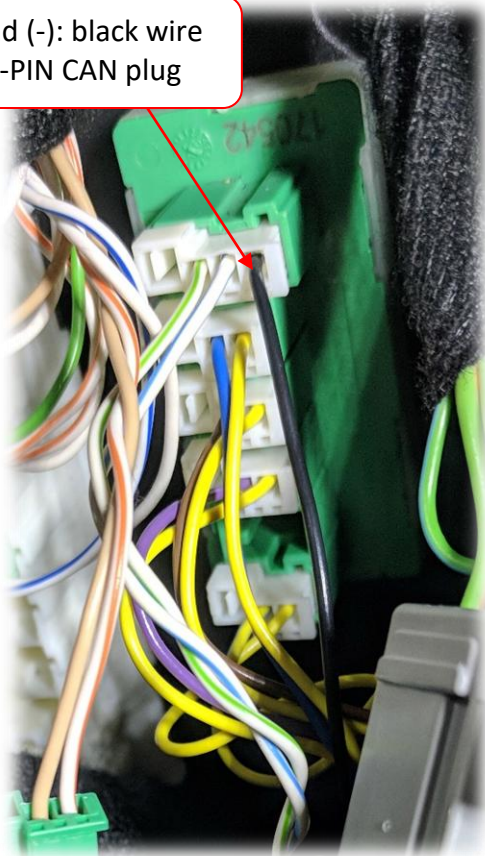

Constant Power (+):
thick red wire
(taped up harness)

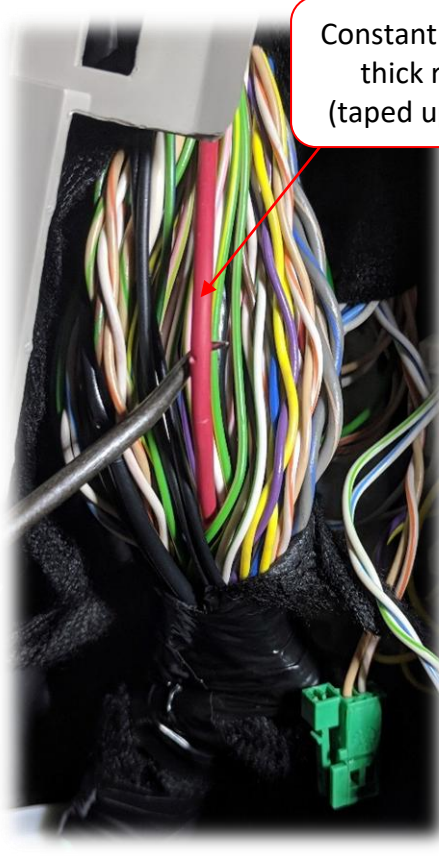

7. Reconnect the modified 2-PIN CAN plug to the same empty bank from step 3.

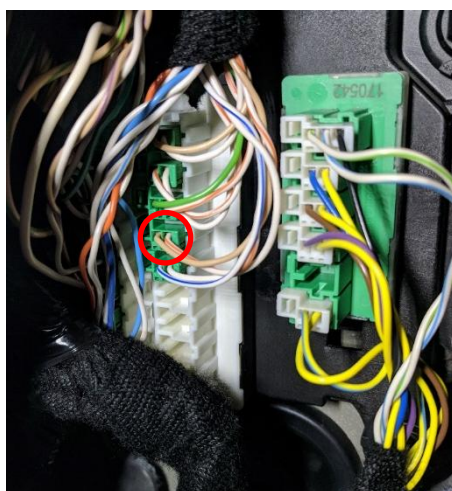

CHRY-RSE VIM wiring diagram

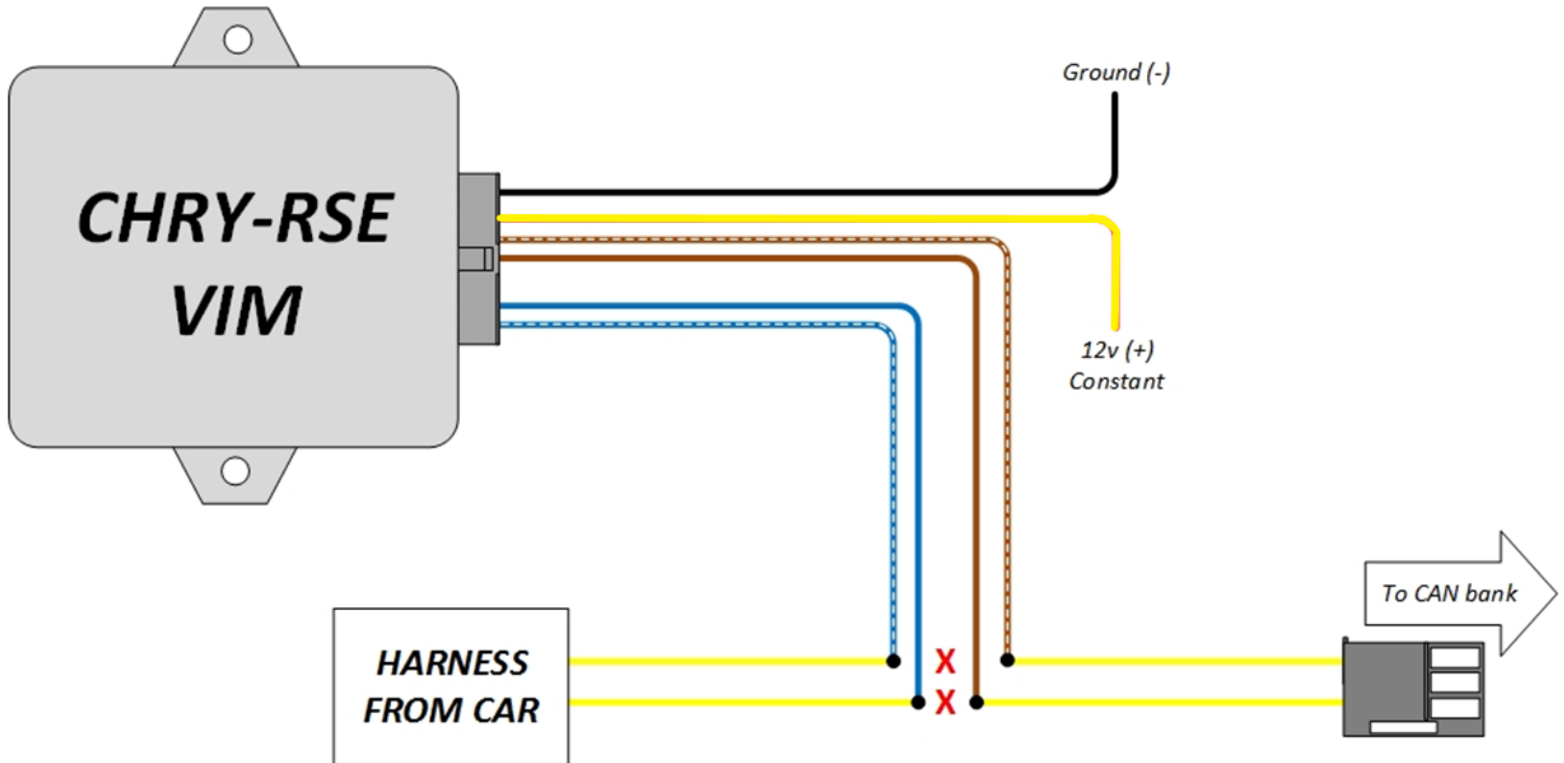

CHRY-RSE VIM Operation

- The CHRY-RSE VIM requires no interaction from the user. Once inside the uConnect Theater (video display) menu, Video In Motion will be enabled.

NAV-TV
INTERFACING THE FUTURE



Agreement: End user agrees to use this product in compliance with all State and Federal laws. NAV-TV Corp. would not be held liable for misuse of its product. If you do not agree, please discontinue use immediately and return product to place of purchase. This product is intended for off-road use and passenger entertainment only.