

NAV-TV

INTERFACING THE FUTURE

3950 NW 120th Ave, Coral Springs, FL 33065 TEL 561-955-9770 FAX 561-955-9760

CHRY MULTI-CAM

Dodge/Jeep uConnect (RA4) Interface with 6 video inputs

NTV-KIT764



Overview

The *UCTv2* series Interface integrates multiple video inputs to the factory 8.4" touch screen in compatible 2013+ Dodge and Jeep vehicles, with additional expansion options for future upgrades.

UCTv2 (KIT762): Add up to 2 additional inputs (or 1 input while retaining OEM camera).

UCTv2+ (KIT763): Same functionality as the standard system, but includes an AVSW for audio integration (AV input).

CHRY MULTI-CAM (KIT764): Same functionality as the standard system, but includes a data-controlled **SVS-6** switcher capable of adding 6 additional video inputs all while retaining any existing OEM cameras.

NOTE: The *CHRY MULTI-CAM* kit is **required** for RAMs that have an OEM Cargo Camera or to emulate the Cargo Camera menu.

Kit Content



Plug & Play T-harness
NTV-HAR246/264



UCTv2 Module (KT2)
NTV-ASY245



SVS-6 I/O Harness
NTV-HAR268



SVS-6 module
NTV-ASY224



USB Cable (updates)
NTV-CAB009



**Used only on vehicles
equipped with OEM
reverse camera**

D2C-R Module
NTV-KIT856

Agreement: End user agrees to use this product in compliance with all State and Federal laws. NAV-TV Corp. would not be held liable for misuse of its product. If you do not agree, please discontinue use immediately and return product to place of purchase. This product is intended for off-road use and passenger entertainment only.

CHRY MULTI-CAM pin out

PIN #	Description	Color
1	12v (+) Constant	Yellow
2	INPUT 1: VIM Activation*	Red
3	--NOT USED--	Blue
4	INPUT 3: Front CAM/Cargo Cam (selectable)	Pink
5	(RX) INPUT (UART control from SVS-6 TX)	Brown
6	RCA MALE	--
7	RCA Shield	--
8	CAN HI (Radio Side)	Brown/White
9	CAN HI (Car Side)	Blue/White
10	Ground (-)	Black
11	OUTPUT 1 Provides 12v (+) ACC OUT	White/Red
12	OUTPUT (2) when AUX is activated (AVSW V1 Trigger)	Blue/White
13	OUTPUT (3) when Front CAM is activated (AVSW V2 Trigger)	Purple
14	(TX) OUTPUT (UART control to SVS-6 RX)	White/Brown
15	RCA Female (Normally Open)	Red
16	RCA Female (Normally Closed)	White
17	CAN LO (Radio Side)	Brown
18	CAN LO (Car Side)	Blue

OUTPUTs 2 & 3 send 12v (+) with corresponding button press (force cam)

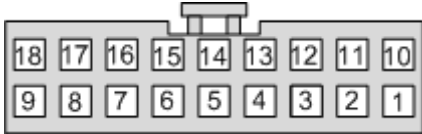

Wire Side

*Not supported on all vehicle models.

D2C pin out

Pin #	Description	Color
1	DIFF INPUT Signal	Yellow
2	12v (+) INPUT	Yellow
3	Composite OUT Signal	Yellow
5	DIFF INPUT Shield	Black
6	Ground (-)	Black
7	Composite OUT Shield	Black

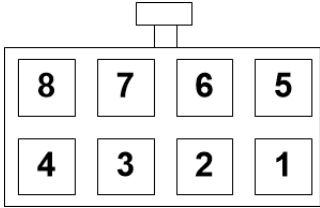

PIN Side



Agreement: End user agrees to use this product in compliance with all State and Federal laws. NAV-TV Corp. would not be held liable for misuse of its product. If you do not agree, please discontinue use immediately and return product to place of purchase. This product is intended for off-road use and passenger entertainment only.

Dash Disassembly (basic RAM)

1. Remove the Torx t20 screw at the right rear of the pocket on the right side of the dash.



2. Remove (2x) Torx t20 at the top of the dash. They are hidden beneath a rubber mat.



3. The face should be free now, pull straight outwards (towards you) with medium force. Use plastic panel tools if necessary.



4. Remove (4x) 7mm screws that secure the LCD touchscreen.



CHRY MULTI-CAM Module Installation

1. After removing the factory radio, grab the provided **Plug & Play T-harness** and connect the female side to the factory 44-pin plug. Make certain the lock connects together securely.
2. Install all cameras and run signal/power leads into the front dash opening. **Note:** 12v ACC is provided from **output 1** (PIN 11, white/red). **If connecting multiple cameras, trigger a relay with this output instead to power your cameras!**
3. The provided Plug & Play T-Harness contains red & black AUDIO RCA's in the center of the plug & play section. If not adding any AV source for this install (AVSW), connect these together. ***If left disconnected, audio will not pass through the system properly.***
4. Connect the male 'VIDEO OUT' RCA to the 'REAR CAMERA' RCA among the Plug & Play T-Harness of the UCTv2.
5. Connect the **TX wire** (PIN 14, white/brown) from the UCTv2 to the **RX wire** (PIN11, brown/black) on the **SVS-6** module.
6. Ground the **black wire** and provide **ACC 12v (+)** to the **SVS-6** module using **output 1** from the **UCTv2** module.
7. Connect video source signals to the **SVS-6** module that you are using for this install. **NOTE: if the vehicle has an OEM rear camera: connect the male, radio-side RCA among the (UCTv2) Plug & Play T-Harness through the provided D2C module, then to the 'Rear Cam' RCA on the SVS-6 module to retain it normally (see below, and diagrams on next page).**

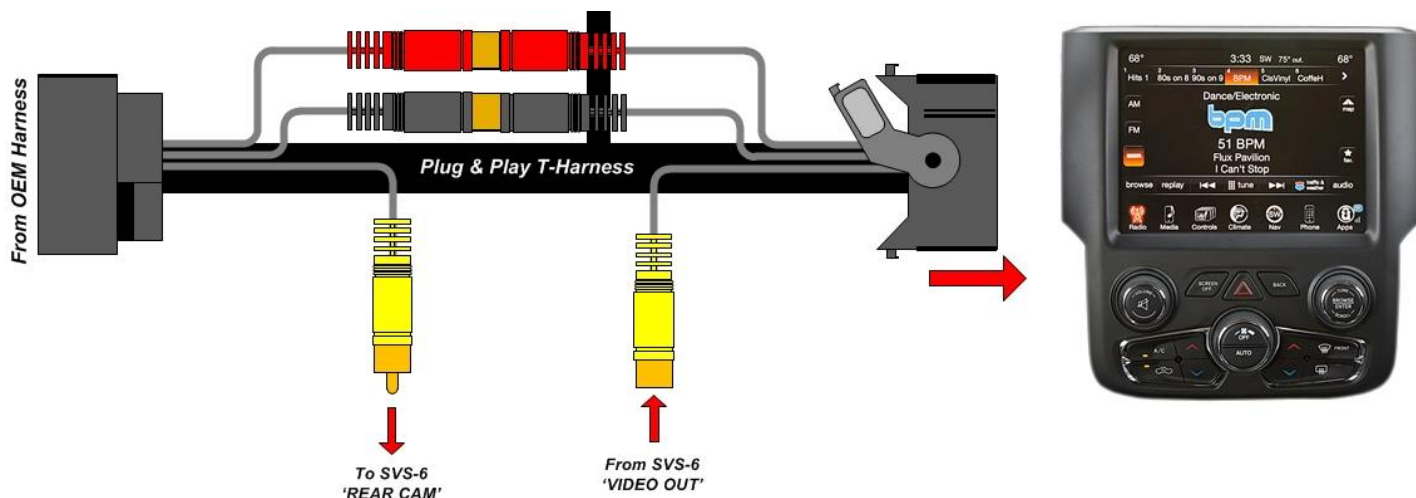

8. **Do NOT connect any other wires on the SVS-6 module - the serial data sent via the TX/RX wires handle triggering.**
9. Set the DIP Switches properly for MULTI-CAM use on the SVS-6 (1 UP and the rest DOWN).
10. **Optional:** If this is a '13-'15 RAM vehicle and the user wishes for both OEM cameras (Tailgate & Cargo) to be displayed on the main 8.4" media screen, see page 6 or 7.
11. Connect the male side of the **Plug & Play T-Harness** to the main radio display. Proceed to page 10 & 11 for programming.



This page is ONLY used for 2013-2015 RAM vehicles, when the user wants both OEM cameras (cargo & tailgate) to display on the 8.4" screen (Cargo normally shows on mirror). For 2016 RAM, continue to next page instead.

- If the vehicle possesses both **OEM** cameras (reverse tailgate cam on the rearview mirror and cargo cam on the main 8.4" screen), force both cameras to display on the main 8.4" screen by completing the following:
 - a. Extend (splice, do not cut) the OEM tailgate signal with a **Single RCA cable (shield & signal)** to the main radio location. There are two easily accessible locations for tapping this RVC signal:
***Note: If the OEM tailgate RVC signal is cut in half, the rearview-mirror image will display an error while in reverse. SPLICE into these wires, DO NOT CUT!**

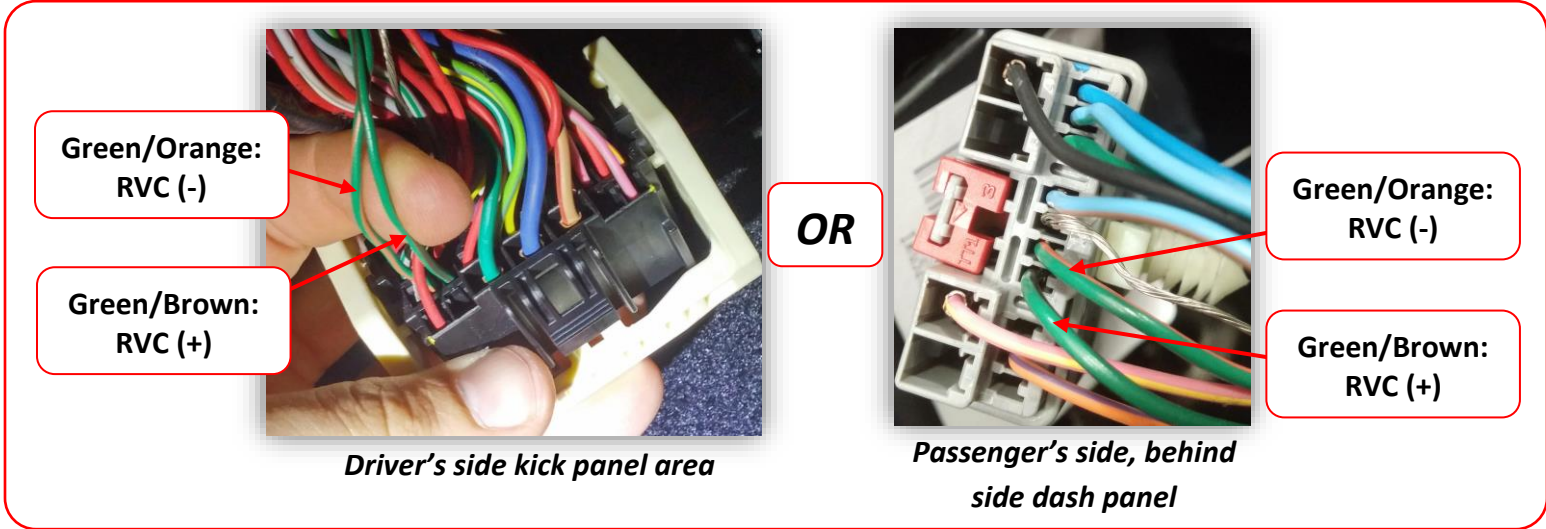

- b. Connect your **extended tailgate signal (RCA)** from step 5.a. to the RCA labeled 'Cargo/Trailer CAM' on the 24-pin plug of the **SVS-6** module.
- c. Make sure you set **Cargo Cam** to '**FIX**' (after first setting to ON and verifying the menu has been emulated) in NAVTV Settings while programming the UCTv2.

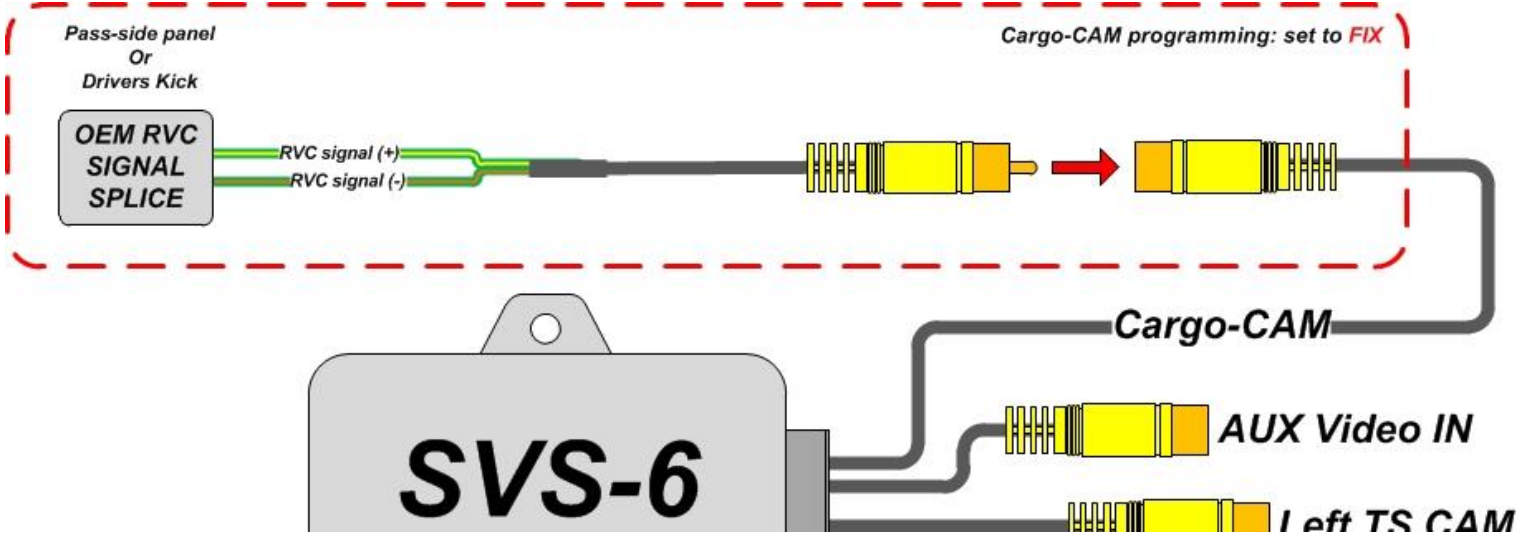

Agreement: End user agrees to use this product in compliance with all State and Federal laws. NAV-TV Corp. would not be held liable for misuse of its product. If you do not agree, please discontinue use immediately and return product to place of purchase. This product is intended for off-road use and passenger entertainment only.

*This page is ONLY used for 2016 RAM vehicles, when the user wants to add an aftermarket Cargo Camera and be able to select (view) it exactly like factory (touch icons while in reverse or from Cargo Cam Menu).
For '13-'15 RAM, see previous page (6) instead.*

1. **For 2016+ RAM trucks only**, emulate the **CARGO CAM MENU** and selection icons (shown in *reverse only* – see pic at right) by turning the **CARGO CAM** selection to 'ON' in the programming menu (must choose 'SVS6' for 'SWITCH'.

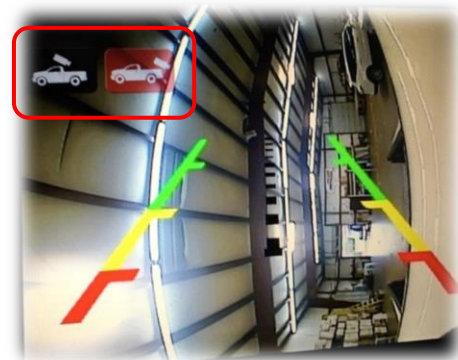

2. Connect the added Cargo Camera signal to the **Blue RCA** among the provided **Plug & Play T-Harness**. **NOTE: This blue RCA is ONLY for use in 2016+ RAMs.** For RAMs 2015 and older, connect signal directly to the SVS-6 (see page 6).

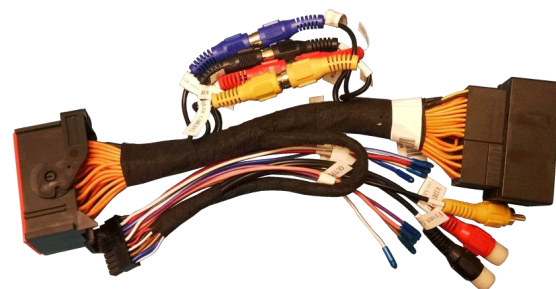

3. After making connections and programming **CARGO CAMERA** to **ON**, the vehicle must receive a **FULL CAN-BUS RESET** before the emulation will function.
 - o Perform a **CAN-BUS reset** by shutting the vehicle down, closing all doors and locking the vehicle. Return in 10 minutes and start vehicle, test for proper operation.

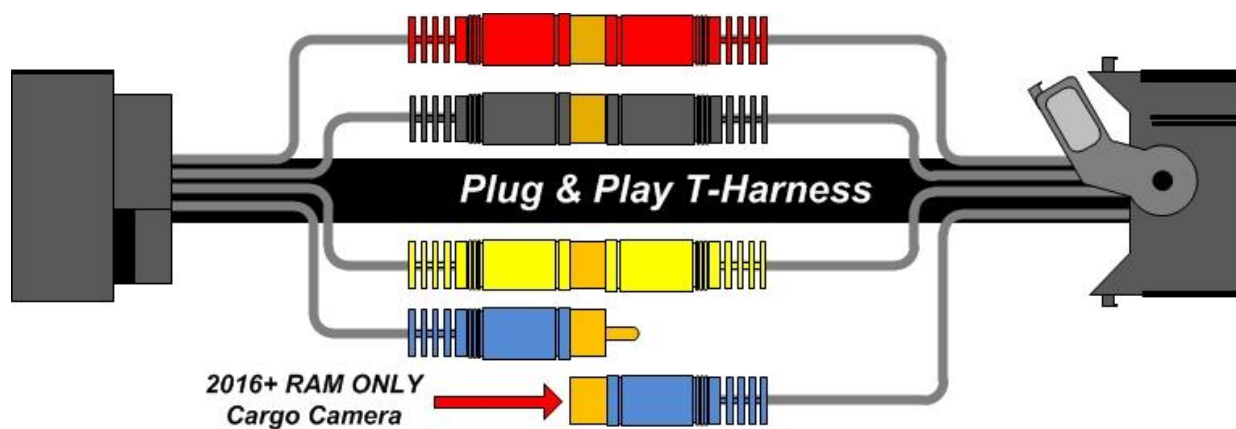

CHRY MULTI-CAM Install Diagram

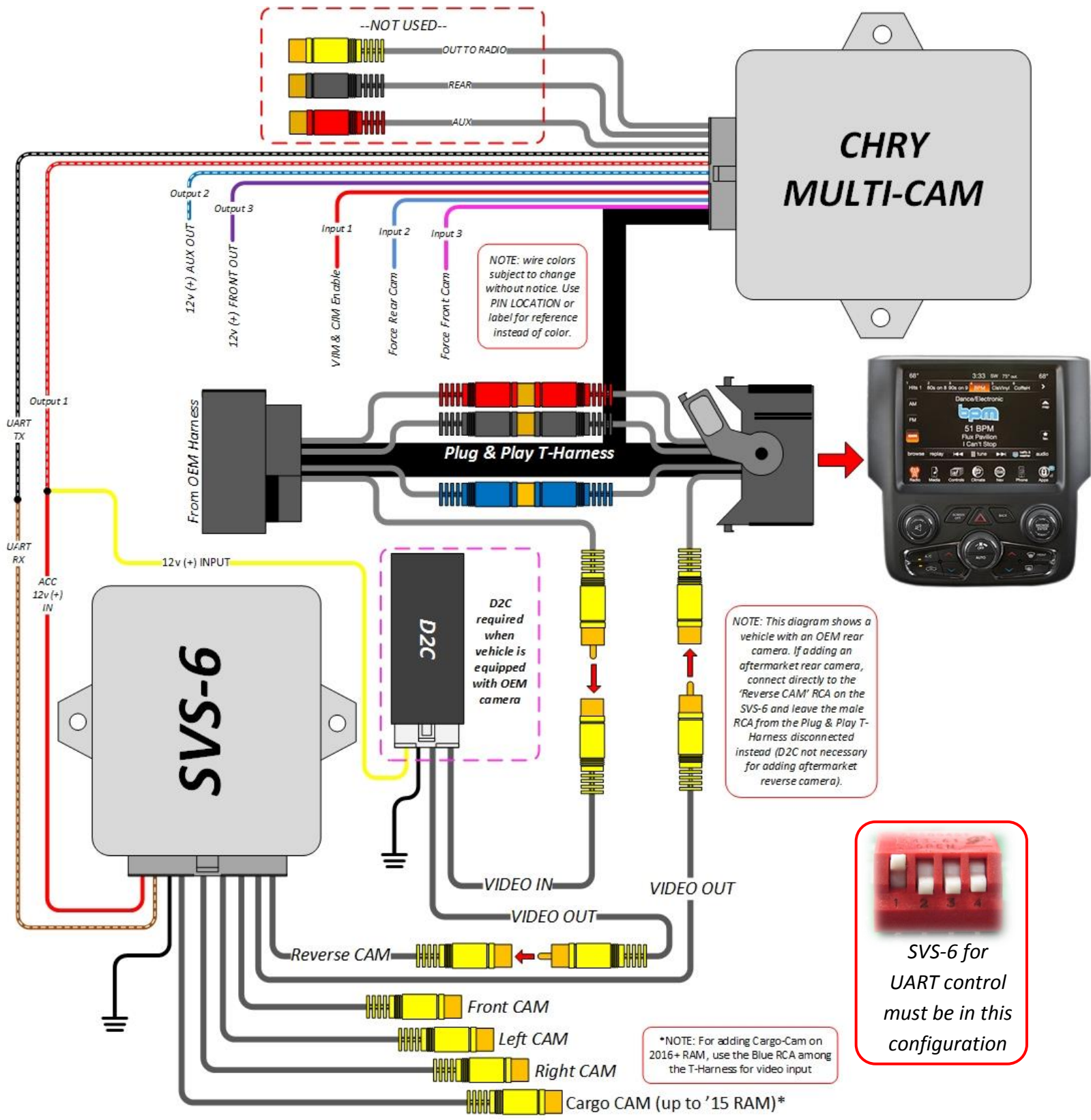

Agreement: End user agrees to use this product in compliance with all State and Federal laws. NAV-TV Corp. would not be held liable for misuse of its product. If you do not agree, please discontinue use immediately and return product to place of purchase. This product is intended for off-road use and passenger entertainment only.

CHRY MULTI-CAM with AUX AV Install Diagram

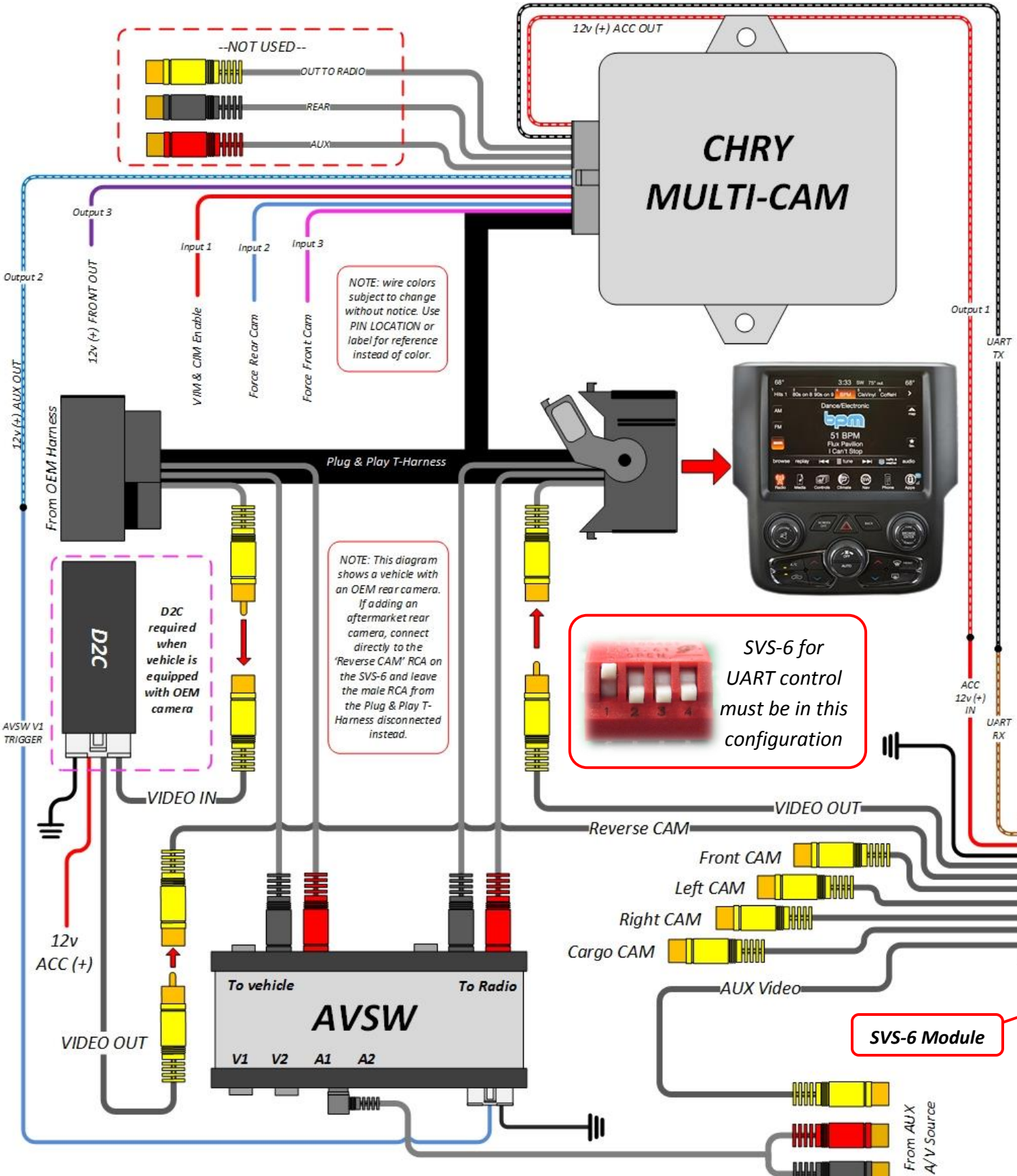

If you do not agree, please discontinue use immediately and return product to place of purchase. This product is intended for on-road use and passenger entertainment only.

CHRY MULTI-CAM Programming

Programming the CHRY MULTI-CAM is performed in the vehicle, through the factory dash MUTE button, TUNING KNOB, and CLUSTER LCD for feedback (true LCD cluster-equipped vehicles only)

Press and HOLD
(15 seconds)
to enter NAV-TV
settings mode



While in NAV-TV
settings mode only:
Rotate clockwise
(**slowly**, one
detent/time) to
scroll through
options. Press ENTER
to change setting.

1. Before attempting to program, after making connections, let the vehicle perform a CAN-reset: Close all doors/trunk/hood, lock the vehicle and waiting 10 minutes before proceeding to program.
2. Turn the vehicle's ignition on. Be certain you're resting in **FM mode** (see an FM station frequency on the cluster), otherwise the cluster information may not display.



To show the FM source on the **cluster**, first clear any messages shown (door status, etc) with the UP or DOWN arrows on the steering wheel. Press the audio source button until 'FM' is displayed.

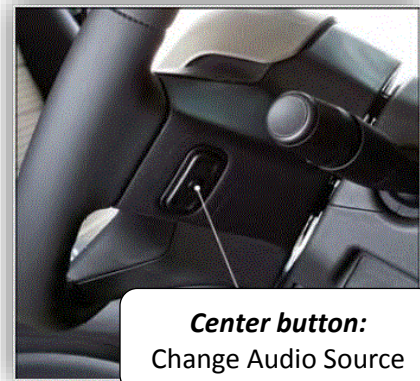

Center button:
Change Audio Source

3. Close all doors (*door status may override NAV-TV settings cluster feedback*).
4. View the chart on the next page for settings descriptions and the diagram above to begin programming.
5. NAV-TV programming mode will time out (back to factory) after 15 seconds. **Scroll to the end of the settings menu and select 'EXIT' to exit and save settings.**

CHRY MULTI-CAM Programming Parameters (OEM Cluster)

Parameter (cluster)	Adjustment Options	Description
NAV-TV Settings	TUNE-Next Item / Enter Change	Rotate TUNE knob to access different menus, press knob inwards to enter/change setting
GEAR	AUTO / STICK	AUTO: Select this option if the vehicle has an automatic transmission STICK: Select this option if the vehicle has a manual transmission
SWITCH	RELAY / AVSW / SVS-6	RELAY: Uses RCA inputs on the UCTv2 module itself (UCTv2) AVSW: Select when using AVSW board (UCTv2+) SVS-6: Select when using SVS-6 switcher (CHRY MULTI-CAM)
RVC	OEM / AFTERMARKET / OFF	OEM: Vehicle has a manufacturer-installed reverse camera. AFTERMARKET: Any aftermarket reverse camera. OFF: Choose if not adding a reverse tailgate camera.
F. RVC	OFF / ON	ON: Enables option of forcing rear view camera.*
FRONT CAM	OFF / ON / <8	ON: Enables option of installed front camera. <8: Front camera will display between 1-8 MPH.
AUX VID	OFF / ON	ON: Enables option of AUX VIDEO
URNS	OFF / ON / >25 / >30 / >35	OFF: Use when not installing turn signal cameras. ON: Turn signal cameras will be active all the time, regardless of speed. >25: TSCs will only activate > 25 mph >30: TSCs will only activate > 30 mph >35: TSCs will only activate > 35 mph
Cargo CAM**	OEM / ON / FIX	OEM: No Change. ON: Emulates Cargo CAM menu. FIX: Displays both OEM cameras on main 8.4" display***
INPUT3	CARGO / FRONT	CARGO: Sending 12v (+) forces the connected Cargo Camera. FRONT: Sending 12v (+) forces the connected Front Camera.
EXIT	EXIT	Exits programming mode and saves changes.



The **SWITCH** you choose determines which options will display on the cluster, to reduce confusion.

Option color	SWITCH chosen:
Grey	ANY
Orange	AVSW
Purple	SVS-6
Blue	SVS-6 on RAM only

*Factory Rear camera is controlled via LIN. Forced OEM RVC is not supported with the MULTI-CAM.

** When setting Cargo CAM to 'FIX': Set Cargo CAM to ON, then exit and **verify the menu has been emulated.** After cargo menu verification, go back to the NAV-TV settings menu and set to 'FIX' for proper operation.

***Requires extending the tailgate camera signal from passenger side dash or drivers kick to the main display.

Programming for 2016+ Vehicles equipped with Panasonic Radios (CarPlay/Android Auto)

- For 2016+ vehicles equipped with the new Panasonic radio, if adding a rear camera, the method for activating rear-camera has changed and requires additional (startup/shut down) steps. Follow the procedure below **after programming desired options in the NAV-TV cluster menu** in these vehicles:
 1. Open the driver's door and leave it open until step 4.
 2. After Installing the kit and adjusting the menu for desired options, shut down the vehicle with the key (or push button). **Wait for the LED on the module to go out – the CAN bus must remain undisturbed for 2 minutes at this point (starting from after the LED is out).**
 3. Turn the vehicle on and wait for the radio to boot fully (able to control volume/adjust radio). **Wait 1 minute with normal operation.**
 4. Turn the car off and perform a **full CAN reset**: Close all the doors, lock the car with the remote and walk away for at least 10 minutes. *Do not disturb the car whatsoever for 10 minutes.*
 5. Return to the vehicle and start the car (run), place the vehicle into reverse to verify that the system received the programming.

For further information on this process and video reference, see our YouTube video here:

<https://www.youtube.com/watch?v=XOtkOUCLXik>

CHRY MULTI-CAM Force Buttons

Force front camera: Press & hold (2 sec) to activate

AUX: Hold both 'SCREEN OFF' & 'BACK' (2 sec)

Force rear camera: Press & hold (2 sec)

CIM*: Hold (3 sec) to activate (not supported for 2016s)

Force Cargo CAM: Double-tap when in reverse only (RAM ONLY)

Truck Chassis: RAM, Durango or Grand Cherokee

**Not supported on all vehicle models.*



CIM*: Hold (3 sec) to activate (not supported for 2016s)

Force rear camera: Press & hold (2 sec)

Force front camera: Double-tap Front Defrost

AUX: Double-tap Rear Defrost

Car Chassis: Charger, Challenger, 300 & Viper

Agreement: End user agrees to use this product in compliance with all State and Federal laws. NAV-TV Corp. would not be held liable for misuse of its product. If you do not agree, please discontinue use immediately and return product to place of purchase. This product is intended for off-road use and passenger entertainment only.

CHRY MULTI-CAM Operation Information

Rear Camera Operation: Placing the vehicle in to reverse will automatically display any connected camera. This image will take precedence over all other images.

Force Rear Camera: To force rear camera, press and hold radio **'BACK'** button for 2 seconds. To exit forced rear camera, press and release radio **'BACK'** button. **Note:** *forced rear camera is only supported on aftermarket cameras.*



Force Front Camera: To force front camera, press and hold radio **'SCREEN OFF'** button for 2 seconds (truck chassis) or **'FRONT DEFROST'** (car chassis). To exit Front Camera mode, press and release the **'BACK'** button.

- If using AUX video mode for an A/V source, the red & black RCAs located on the *Plug & Play T-Harness* must be opened up with an AVSW (KIT763 includes AVSW, or it can be ordered separately as NTV-KIT224).



Activate Aux Video mode: To activate the AUX screen, press and hold both radio **'SCREEN OFF'** & **'BACK'** buttons together for 2 seconds (truck chassis) or **'REAR DEFROST'** (car chassis). To exit AUX mode, press and release radio **'BACK'** button.



Cargo CAM: When Cargo CAM is set to 'ON' in the NAVTV Settings menu, the OEM Cargo Cam menu will be emulated on the radio. This will allow the option for forcing an added Cargo/Trailer/Baby camera (or displaying both on the main screen). **NOTE: if using this feature (FIX), set Cargo Cam to ON, then verify the menu is emulated. Then go BACK into settings and change to 'FIX'.** Press the 'Cargo Camera' button located in the 'Controls' tab on the main radio screen to display the camera connected to the Cargo CAM RCA. **This option requires a full vehicle CAN reset, or radio disconnect/reconnect.**

- If the user has and desires **both OEM cameras (Cargo CAM and Reverse CAM)** to display on the 8.4" screen, additional installation is needed, see Pg. 7 & 8. The Cargo CAM option must be set to 'FIX' for this setup to work properly.
- After activated, while the vehicle is in motion, the **OEM Cargo Camera** will time out in about 5 seconds. For viewing the Cargo Camera for a longer duration (3 mins), activate the CIM function. See next page.
- **NOTE: Cargo Camera option is ONLY available in RAM vehicles.**



2015 RAM Cargo Menu shown. For 2016 RAMs, the cargo icon should appear in the 'APPS' screen, or while in reverse gear only.

CHRY MULTI-CAM Operation Information (continued)

Turn Signal Cameras: To display TSCs, simply use the turn signals as you would normally and the connected image will display either all the time (while in drive), or only after 25, 30 or 35 mph respectively, depending on what was set in MULTI-CAM programming.

- Additionally, the user may use a “bump method” to view the TSC quickly. Toggling the turn signal level quickly (just enough to engage the bulb) will display the TSC image for about 3 seconds.



Activate CIM* (Control in Motion): To activate CIM for factory navigation, press and hold the 'Volume' button for 3 seconds (CIM will disable automatically after 3 minutes). This function will also keep the Cargo Camera enabled for 3 minutes, and will reset upon every key cycle.

NOTE: Activating the CIM function will NOT bypass video in motion at this time, if equipped.



**Not supported on all vehicle models.*

FAQs

Q1. I can't get into programming mode.

A1. Turn off the vehicle and remove the key. Close all points of entry and use the remote to lock the vehicle. Wait approx. 5 minutes without opening or disturbing the vehicle. Unlock and cycle the ignition to the 'RUN' position. **Make certain that the cluster is in FM radio mode before you begin programming;** and no errors are displayed (door open, etc), otherwise the cluster information might not display. Hold down the "MUTE" button until you see the display options post on the cluster.

Q2. When I try to force (front, rear) camera, nothing happens.

A2. Make certain you've enabled the options you want to use in the NAVTV settings mode and that you scrolled to the end *and selected 'EXIT' (or it will not save).*

Q3. I hear no audio when my auxiliary source is playing on screen.

A3. Verify that the audio RCAs are connected properly to the AVSW.

Q4. Everything works properly, but when an audio source is connected to the 3.5mm audio jack, there's no audio.

A4. Make sure the audio RCAs are connected together on the Plug & Play harness.

Q5. When I place the vehicle into reverse, I get a black or blue screen.

A5. Make sure the camera is getting sufficient power and the RCA is connected to the proper yellow RCA on the 24-pin harness.

Q6. The camera image is displayed properly when the vehicle is in reverse, but there's only a black or blue screen when the camera is forced.

A6. Make sure the camera power is not connected to the reverse lamps. Camera power needs to be connected to an accessory wire (cigarette lighter). If the camera is OEM, forcing it to display in any gear is *not* supported.

Other MULTI-CAM Notes:

- When multiple cameras are connected, the MULTI-CAM will clear back to the factory image **after 3 cameras have been forced in succession. This is normal.** I.E: If you had AUX mode displayed on screen, turned the left turn signal on (which will display), then rolled up to an obstacle which forced the front camera, placing the vehicle into park will then display the factory image (*will not return to AUX image automatically*).
- Cluster feedback only displays while programming (NAVTV Settings).
- Cargo Camera usage will only display for about 8 seconds when in motion, then will time out (this is a factory limitation). Activating the CIM feature will retain this image for 3 minutes if desired.
- When setting Cargo Cam to 'ON' or 'FIX', you must let the vehicle perform a full CAN reset, after programming, before the menu will display properly.

NAV-TV

INTERFACING THE FUTURE



Agreement: End user agrees to use this product in compliance with all State and Federal laws. NAV-TV Corp. would not be held liable for misuse of its product. If you do not agree, please discontinue use immediately and return product to place of purchase. This product is intended for off-road use and passenger entertainment only.