

NAV-TV

INTERFACING THE FUTURE

3950 NW 120th Ave, Coral Springs, FL 33432 Tel. 561-955-9770 Fax. 561-955-9760 www.nav-tv.com info@nav-tv.com

W221CAMUSB

03-18-2015 BHM

Rev 6

NTV-DOC010

W221CAMUSB

NTV-KIT111/464

KIT111: No OEM camera KIT464: With OEM camera

Camera Interface for 2007 – 2009 Mercedes-Benz S-Class, CL-Class

Kit Contents



W221 Harness
NTV-ASY031



W221-CAM Module



Male RCA
NTV-CAB072



Female RCA
NTV-CAB071



Female RCA
NTV-CAB006



Female RCA
NTV-CAB005



USB Cable
NTV-CAB009



VSW-R Trigger Harness
NTV-HAR066



VSW-R Switcher
NTV-ASY187



VSW-R I/O Harness
NTV-HAR301



120 OHM Resistor
NTV-RES134

V1 Switcher shown here, this has been replaced with the VSW-R in 03/15

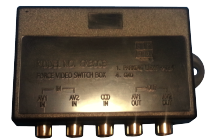

Radio Removal

1. Pop out cover under radio. Remove (2) T20 Torx screws from behind cover.
2. Remove (2) T20 Torx screws from behind hidden cover above radio cover hinges.
3. Remove (4) T20 Torx screws securing the radio in place. Then remove and unplug radio.

Radio Dash Images

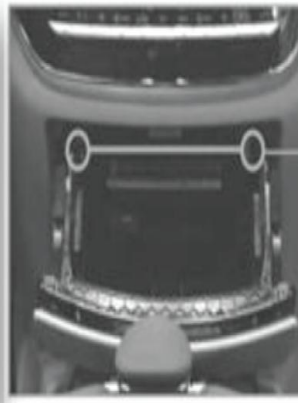

Installation Instructions

Pinout	Car wiring	W221 CAM Wiring
+12 Volt	Pin (10) Thick Red	Pin (7) Red
Ground	Pin (20) Thick Brown	Pin (3) Black
CAN High	Pin (1) Yellow / White	Pins (1, 5) Yellow / Black
CAN Low	Pin (11) Yellow	Pins (2, 6) Yellow
Video +	Pin (7)	
Video -	Pin (17)	
Right Audio	Pin (5)	Red RCA +
Left Audio	Pin (15)	Black RCA +
Common Audio	Pins (6, 16)	RCA Shield -

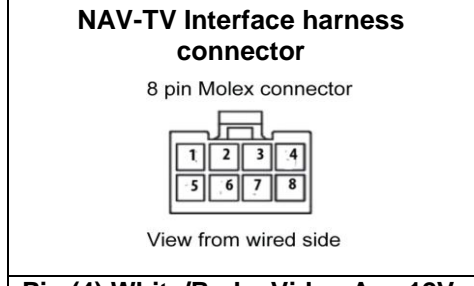
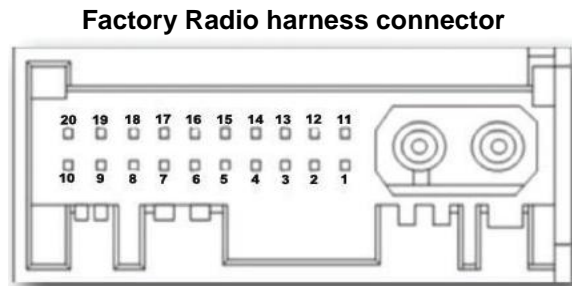

Pin (4) White/Red – Video Acc 12V out. 500mA Max!!!!

Pin (8) White/Blue – Reverse 12V out. 500mA Max!!!!

NOTE: The W221CAM module operates in (2) configurations. It can either be used to add a backup camera to a vehicle or to enable an additional video input on a vehicle that is already equipped with a factory backup camera. Depending on the desired configuration the module can be programmed for **Filter: OFF** when adding a camera or **Filter: On** when a camera already exists. The configurations can be changed by using the USB Updater (downloaded from www.nav-tv.com). The initial configuration when the module is shipped is designated on both the product box and the module itself.

The installation of the module is also dependant on the vehicle's configuration, so please verify the availability of the factory camera prior to installation, and re-program the module if necessary.

Wiring WITHOUT Factory Camera: Filter Off	Wiring WITH Factory Camera: Filter On
<ol style="list-style-type: none"> 1. Solder TOP CAN pair, Yellow/Black and Yellow, to the matching wires on the Radio Connector (Pins 1 & 11) DO NOT CONNECT THE BOTTOM PAIR. 2. Solder supplied 120 ohm resistor across CAN High and CAN Low, Radio Side of interface harness (Pins 1 & 2) 3. Insert Female Red Video RCA connector into cavities 7 (Signal) & 17 (Shield) on the Radio connector. Connect Camera or Video Switcher to RCA connector <p style="text-align: center;">INSTALLATION NOTES REMOVE THE OUTER SHELL FROM CD CHANGER PLUG TO INSTALL AUDIO AND VIDEO INPUTS</p>	<ol style="list-style-type: none"> 1. Cut vehicle CAN wires, Yellow/White & Yellow on Radio connector. Solder Top CAN pair to vehicle side of factory harness. Solder Bottom CAN pair to radio side of factory harness. Yellow/Black to Yellow/White and Yellow to Yellow. 2. Remove factory camera wires from factory radio harness connector (Pins 7 & 17), and connect to supplied Camera input RCA and plug into Video Switcher. 3. Insert Female Red Video RCA connector into factory radio harness connector cavities 7 (Signal) and 17 (Shield). Connect Video Switcher (Video OUT) to RCA connector. 4. Connect the Video Switcher's black wire to ground, white/red wire to the White/Blue wire on the interface harness (Pin 8). The switcher will then automatically activate when in reverse.

AUX Audio Wiring

AUX AUDIO: If vehicle is not equipped with Factory iPod interface, Insert RCA pin into factory radio harness connector cavities 5 (Right Audio), 15 (Left Audio), 6, 16 (Audio Common).

If vehicle is equipped with factory iPod and Aux audio is required, you must cut the existing iPod audio lines at said pins and connect a stereo switcher.



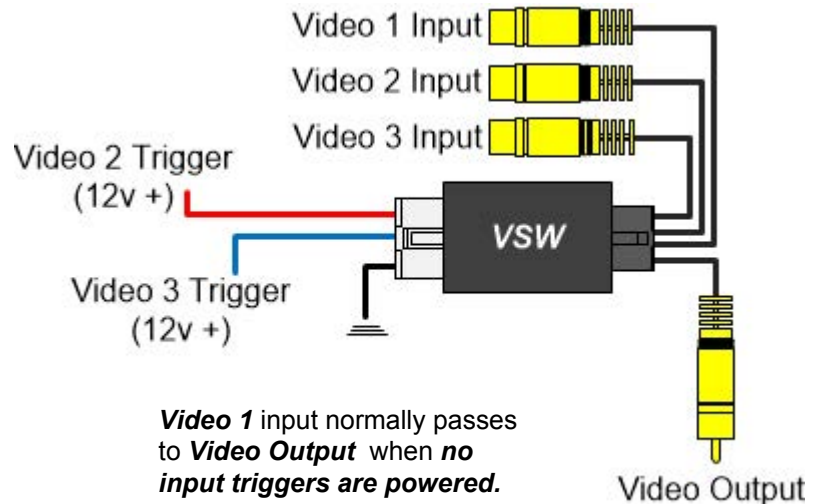

AUX Video Wiring

AUX VIDEO: If adding AUX Video source and a rear camera, use the included VSW-R for switching.

1. Connect the MALE RCA to the Rear Camera input.
2. Connect the AUX Video source RCA to the RCA labeled 'Video 1' for normally passing (shows this source when engaged).
3. Connect the reverse camera signal RCA to the RCA labeled 'Video 2'.
4. Connect the **black wire** from the VSW-R to ground.
5. Connect the **white/red wire** from the VSW-R to the **white/blue wire** of the W221 CAM (reverse output). **Note: Not all cars support reverse out over CAN (white/blue from module). TEST this wire and if 12v is not present while in reverse, manually run a reverse signal and connect to the VSW-R (white/red) instead.**



Agreement: End user agrees to use this product in compliance with all State and Federal laws. NAV-TV Corp. would not be held liable for misuse of its product. If you do not agree, please discontinue use immediately and return product to place of purchase. This product is intended for off-road use and passenger entertainment only.

Programming Interface	Radio Programming Images
<ol style="list-style-type: none"> 1. Press and hold the steering wheel  While quickly tapping the Volume up (+) button 3 times: (Hold ) +++ 2. Release buttons and observe the Cluster and Radio. Both enter DIAGNOSIS mode and then reset. If Radio did not enter DIAGNOSIS, Repeat step 1. 3. After Radio resets, Check the availability of new "AUX" feature under the "AUDIO" Menu. 4. Set the instrument cluster to "Rearview Camera – ON when in reverse". 5. Proceed to checking the system functions described in the "Operations Instructions". 	 <p style="text-align: center;">Press and hold Tap (+) 3 times "DIAGNOSIS"</p>  <p style="text-align: center;">Check "AUDIO" > "AUX" Set Cluster for Camera ON</p>

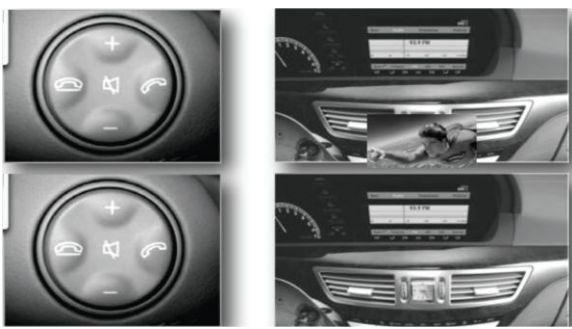
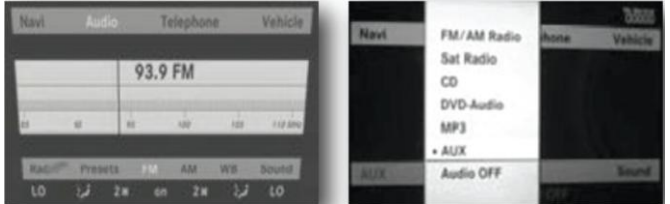
Operation Instructions	
To Activate Rear View Camera	Rear View Camera Image
<ol style="list-style-type: none"> 1. With the brake pedal depressed and engine running, engage reverse gear. 2. Rear View Camera picture will show on COMAND display. 	
To Activate Video Monitoring	Video Activation Images
<ol style="list-style-type: none"> 1. Double Click the Steering wheel Mute button. External Video is now displayed on Comand screen. 2. Double Click the Steering wheel Mute button again to return to normal Comand display. 	
To Activate AUX Audio (option)	AUX Audio Images
Select "Audio" > AUX	

Agreement: End user agrees to use this product in compliance with all State and Federal laws. NAV-TV Corp. would not be held liable for misuse of its product. If you do not agree, please discontinue use immediately and return product to place of purchase. This product is intended for off-road use and passenger entertainment only.