

NAV-TV

INTERFACING THE FUTURE

3950 NW 120th Ave, Coral Springs, FL 33065 TEL 561-955-9770 FAX 561-955-9760

www.nav-tv.com info@nav-tv.com

BMW12N-DYNAMIC KIT

NTV-KIT717

BMW Infotainment System Variants



CCC System: BMW56-N, P/N NTV-KIT724

NOT COMPATIBLE WITH THIS KIT !



CIC System: BMW09-N, P/N NTV-KIT725

NOT COMPATIBLE WITH THIS KIT !



NBT System: BMW12-N, P/N NTV-KIT717

COMPATIBLE WITH THIS KIT



EVO System: BMW EVO V2, P/N NTV-KIT978

NOT COMPATIBLE WITH THIS KIT !

Agreement: End user agrees to use this product in compliance with all State and Federal laws. NAV-TV Corp. would not be held liable for misuse of its product. If you do not agree, please discontinue use immediately and return product to place of purchase. This product is intended for off-road use and passenger entertainment only.

NAV-TV

INTERFACING THE FUTURE

3950 NW 120th Ave, Coral Springs, FL 33065 TEL 561-955-9770 FAX 561-955-9760

www.nav-tv.com info@nav-tv.com

BMW12N-DYNAMIC KIT

NTV-KIT717



Screen
Connector



Quick Reference
(LVDS) Video Cable connects at Screen
Power/CAN T-Harness connects at iDRIVE controller
Unit requires Constant 12v
Do not power camera with reverse light. Use ACC or purple wire (through relay)

Overview

The BMW12-N kit interfaces 2 video inputs (including a backup camera) to the factory media screen in select 2012+ BMWs **with the 6-pin video connector (at the screen)**. This interface generates steering-based guidelines while in reverse for added convenience.

NOTE: Please refer to the cover page of this document for compatible screens.

Kit Contents

HD-LINK Optional KIT-979



BMW12-N Interface
NTV-INT244

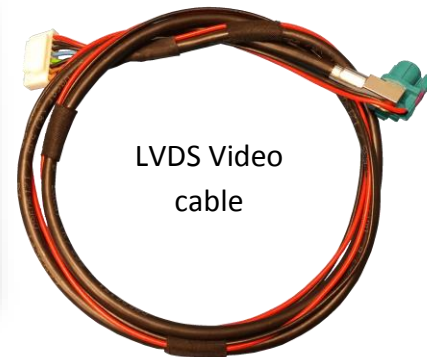

LVDS Video
cable

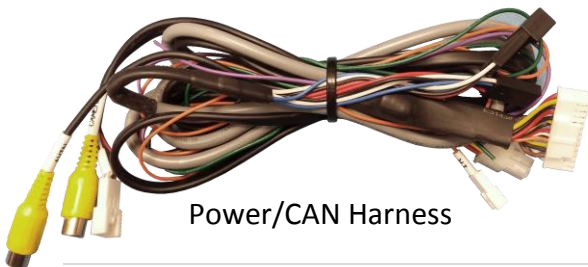

Power/CAN Harness



Remote (menu control)



IR Eye Harness

Agreement: End user agrees to use this product in compliance with all State and Federal laws. NAV-TV Corp. would not be held liable for misuse of its product. If you do not agree, please discontinue use immediately and return product to place of purchase. This product is intended for off-road use and passenger entertainment only.

Interface Connectors

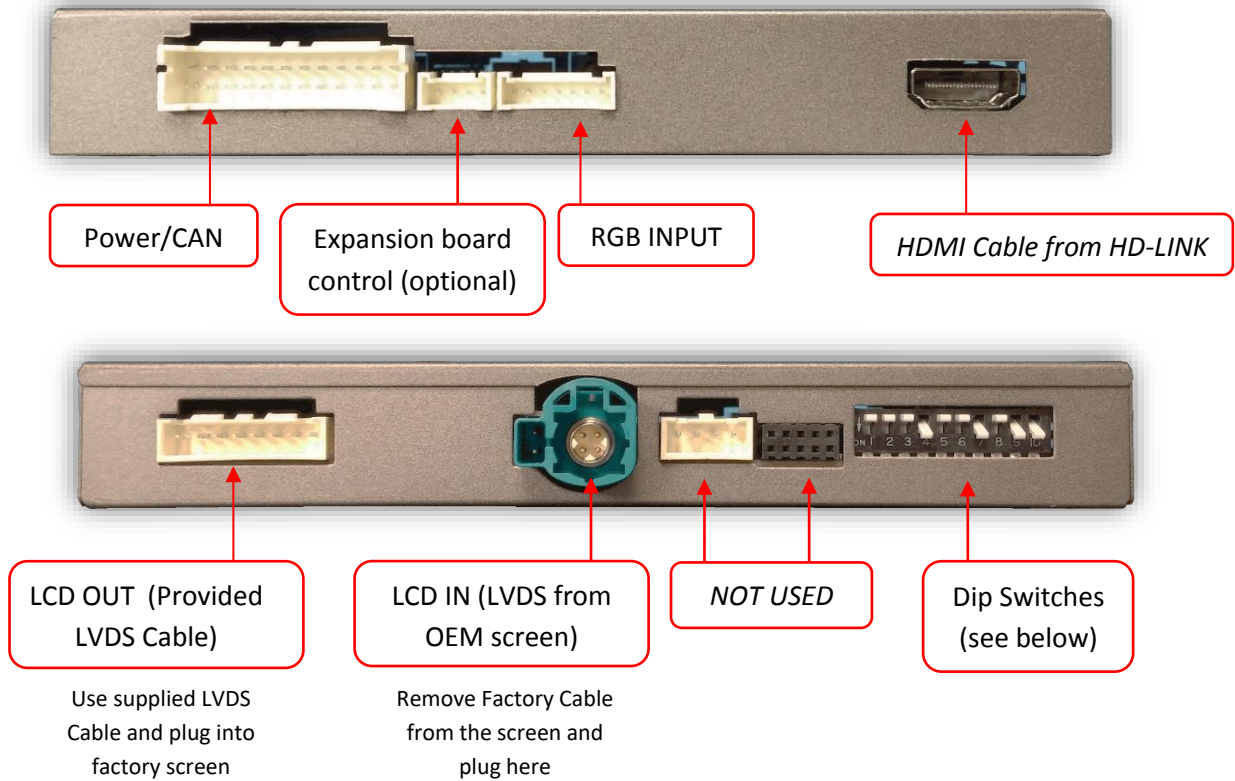

Dip Switch settings*

Dip SW:	DS 1-4 are install dependent				5	6	7	8	9	10
	1	2	3	4						
UP	KEEP UP	SKIPS V1	SKIPS V2	RVC OFF	CAN SETTING	CAN SETTING	CAN SETTING	HIGH RES	VEH SETTING	KEEP DOWN
DOWN	KEEP UP	ENABLES V1	ENABLES V2	RVC ON	CAN SETTING	CAN SETTING	CAN SETTING	LOW RES	VEH SETTING	KEEP DOWN



NOTE: reset power after adjusting dip switches.

***See next page for verified dip switch settings.**

Verified Dip Switch Settings

YEAR(s)	MODEL(s)	DIP SWITCH										Position	
									Screen Size				
		1	2	3	4	5	6	7	8	9	10		
2017	1 Series	Install Dependent					X	X	X	8.8"+	X		UP
			X							6.5"		X	DOWN
2014-15	2 Series	Install Dependent					X	X	X	8.8"+			UP
			X							6.5"	X	X	DOWN
2016	2 Series	Install Dependent						X	X	8.8"+	X		UP
			X	X						6.5"		X	DOWN
2016	2 Series (v2)	Install Dependent					X	X	X	8.8"+	X		UP
			X							6.5"		X	DOWN
2012-13	3 & 5 Series	Install Dependent					X	X	X	8.8"+	X		UP
			X	X						6.5"		X	DOWN
2014-16	3 & 5 Series	Install Dependent						X	X	8.8"+	X		UP
			X	X						6.5"		X	DOWN
2015	3 & 5 Series (v2)	Install Dependent					X	X	X	8.8"+	X		UP
			X	X	X	X				6.5"		X	DOWN
2017	3 & 5 Series	Install Dependent					X	X	X	8.8"+			UP
			X							6.5"	X	X	DOWN
2014-15	4 Series	Install Dependent					X	X	X	8.8"+	X		UP
			X							6.5"		X	DOWN
2013	i3	Install Dependent					X	X	X	8.8"+	X		UP
			X							6.5"		X	DOWN
2016	X1	Install Dependent					X		X	8.8"+	X		UP
			X				X			6.5"		X	DOWN
2017	X1	Install Dependent						X	X	8.8"+	X		UP
			X	X						6.5"		X	DOWN
2017	X1 (v2)	Install Dependent					X	X	X	8.8"+			UP
			X							6.5"	X	X	DOWN
2014-16	X3	Install Dependent					X	X	X	8.8"+	X		UP
			X							6.5"		X	DOWN
2014-16	X3(v2)	Install Dependent					X	X	X	8.8"+	X		UP
			X				X			6.5"		X	DOWN
2014	MINI	Install Dependent					X	X		8.8"+	X		UP
			X					X		6.5"		X	DOWN
2015	MINI	Install Dependent					X	X	X	8.8"+			UP
			X							6.5"	X	X	DOWN
2016	MINI Clubman	Install Dependent					X	X	X	8.8"+	X		UP
			X							6.5"		X	DOWN

Agreement: End user agrees to use this product in compliance with all State and Federal laws. NAV-TV Corp. would not be held liable for misuse of its product. If you do not agree, please discontinue use immediately and return product to place of purchase. This product is intended for off-road use and passenger entertainment only.

BMW12-N Interface Installation (5 Series example)

1. The BMW12-N intercepts **two OEM harnesses in two locations**: the iDrive knob and the screen. You must gain access to both places for proper installation.
 - a. Access the rear of the screen by removing the dashboard panel (clips only) and then removing (2x) Torx T20 screws securing the screen to the sub-dash.



2. To access the iDrive harness, remove the panel surrounding it (may have Torx screw securing to sub dash)

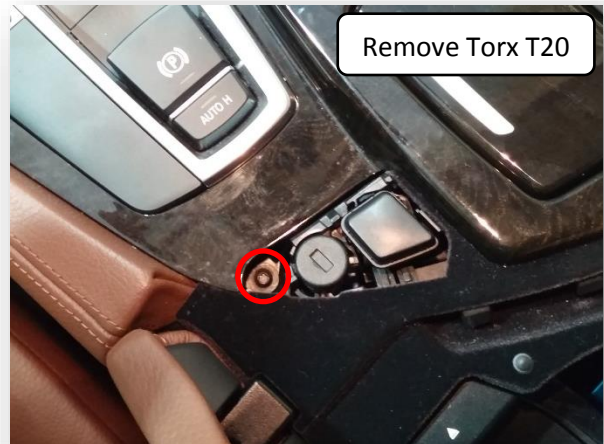
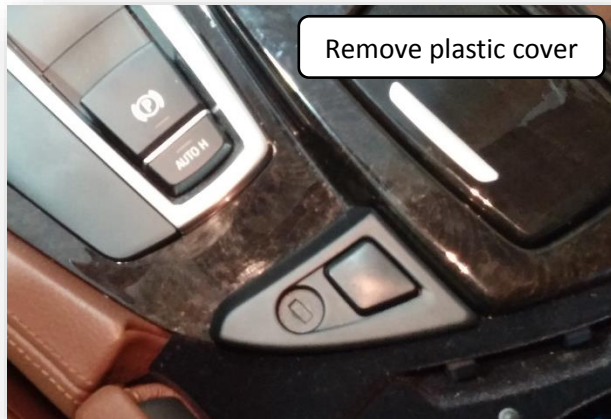

3. Lift up the lower dash panel and disconnect 4-PIN plug powering the iDrive knob.

4. Connect provided 4-PIN T-Harness in between iDrive knob and OEM harness as shown.



Agreement: End user agrees to use this product in compliance with all State and Federal laws. NAV-TV Corp. would not be held liable for misuse of its product. If you do not agree, please discontinue use immediately and return product to place of purchase. This product is intended for off-road use and passenger entertainment only.

4. Replace the lower dash panel (with iDrive knob) back to sub-dash.

5. Disconnect the OEM screen LVDS video cable and connect it to the port on the BMW12-N labeled 'LCD-IN'.



6. Connect the provided LVDS Video Cable to the port on the BMW12-N labeled 'LCD-OUT' and the other end back to the screen.



7. Install and run the reverse camera video source power and signal to the BMW12-N interface location and connect to the RCA labeled 'CAMERA'. **Power your camera with an ACC source (cigarette lighter)** or use the **violet wire to trigger a relay** for reverse 12v (+) only.

NOTE: using the purple wire directly to power your camera is not recommended due to potential current issues (iDRIVE power has only 3 amp fuse).

NOTE2: If this vehicle is equipped with a manual transmission, chances are the module will not switch using CAN data – if this is the case, run a reverse signal from the reverse light through a relay to the green wire on the module for reverse switching.

8. **Optional:** If installing a secondary camera or AUX video source, connect signal RCA to the RCA on the BMW12-N interface labeled 'AVIN'.

7. After DIP switch settings have been set (see page 2), connect the 24-PIN power connector to the BMW12-N interface labeled 'POWER CAN'. Proceed to **Menu Options** section if necessary (front camera settings, etc) or to **BMW12-N Operation**.

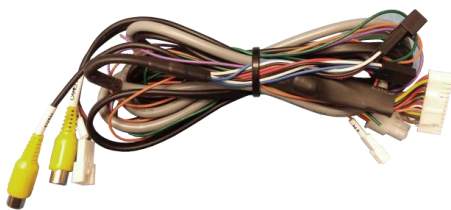

Menu Adjustments

Before you start:

- The IR-Eye must be connected
- Make sure the car's ignition is on and radio is on
- You must be in **Reverse Camera** mode **OR AUX Video** mode (see below):
 - **Reverse Camera Mode** adjusts Reverse Camera Settings
 - **AUX Video Mode** adjusts AUX Video Settings
- Press the **OK BUTTON 4 times** (numbers will display per press), then press **POWER**.
- The **OSD Menu** will appear on screen (auto-time out in about 5 seconds if no action occurs).

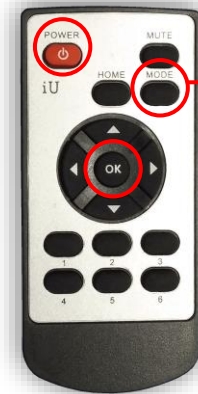

Return
(AUX VID menu control)

RVC Menu

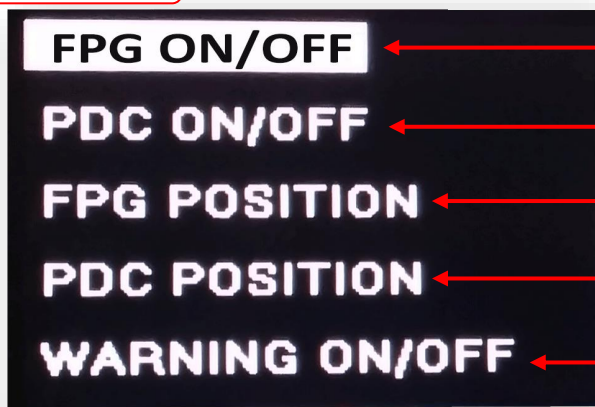

Functional Parking Guidelines ON/OFF

Parking Distance Control ON/OFF (while in reverse)

Adjust FPG Position

Adjust PDC Position

'Safe to move?' ON/OFF

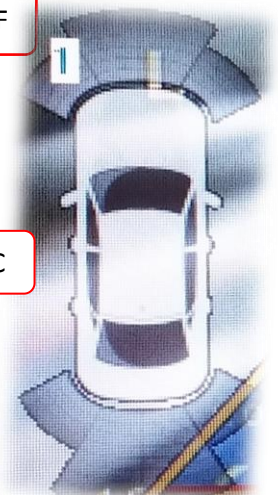

PDC

AUX VIDEO Menu

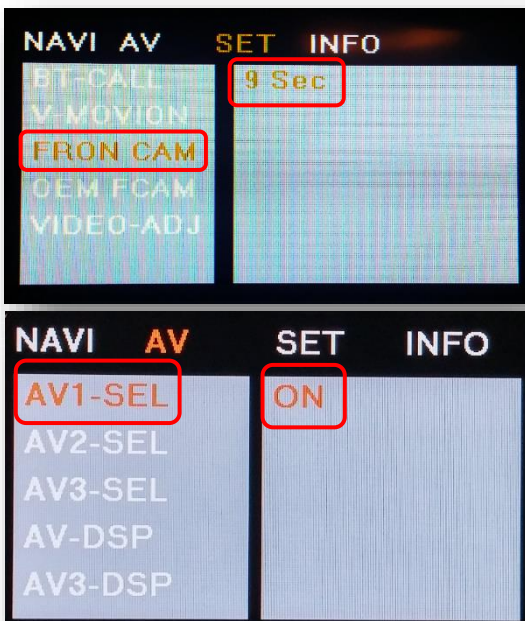

If adding a front camera OR Aux Video source:

1. Disconnect POWER/CAN Harness from interface
2. Place DIP SWITCH 1 in the DOWN position, reconnect power
3. Press and hold the iDRIVE knob '**MENU**' to activate the AUX screen
4. Press **OK** button on remote 4 times, then press **POWER**

SET – FRON CAM must be turned on if adding a front camera **and the user wishes for automatic front camera switching**. Options for 5, 7, 9 or 11 seconds are user-selectable for the length of time the front camera input stays active once the vehicle is placed out of reverse.

If the user wants only an AUX video input **without front camera**, set **AV1-SEL** to **ON**

Once finished with settings, place DIP SWITCH 1 back into the **UP position** and reset power to interface.

Agreement: End user agrees to use this product in compliance with all State and Federal laws. NAV-TV Corp. would not be held liable for misuse of its product. If you do not agree, please discontinue use immediately and return product to place of purchase. This product is intended for off-road use and passenger entertainment only.

Adding HD-LINK Adapter (HDMI Input)

Follow the instructions below when adding the HDMI adapter (HD-LINK) to enable HDMI input to the OEM screen:



1. Put dip switch #1 in the **DOWN** position.
2. Activate the 'NAV INPUT' by **holding** the 'MENU' button on the iDRIVE knob.
3. Once 'NAV INPUT' shows on the screen, on the remote press the **OK BUTTON 4 times**, then press **POWER**.
4. Navigate to the 'NAVI' section.
 - a. Select 'HDMI-SEL'
 - b. Choose 'HD95E'
 - c. Press **MODE** on the remote to return and exit the OSD menu (or let it time out).
5. Replace dip switch #1 to the **UP** position.
6. Connect the **black wire** to ground (-) and the **red wire** to ACC power (+) from the main power connector on the HD-LINK adapter. The RCA's on this plug provide audio from the HDMI source.

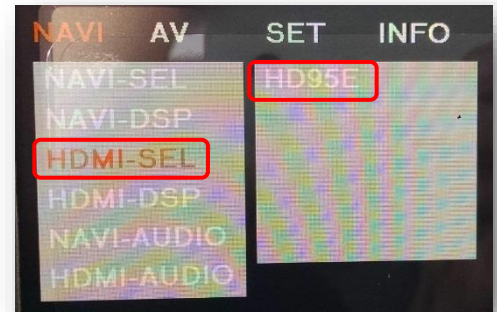

Green Trigger wire setup

This module includes a green *input* wire for analog triggering of either the Reverse camera input or the 'AVIN' input (yellow RCAs), selectable through the AV menu. This allows for adding multiple cameras through the use of an SVS-6 switcher, etc. Follow the steps below adjust this feature. **NOTE: by default, the green wire will trigger the Reverse camera input RCA.**

1. Put dip switch #1 in the **DOWN** position. When this section is complete, return switch #1 **UP**.
2. Activate the 'NAV INPUT' by **holding** the 'MENU' button on the iDRIVE knob.
3. Once 'NO GPS INPUT' shows on the screen, on the remote press the **OK BUTTON 4 times**, then press **POWER**.
4. Navigate to the 'SET' section.
 - o Select 'REVERSE WIRE'
 - o Choose 'AV1', 'REAR' or 'REAR MODE' (explanations below)
 - o Press **MODE** on the remote to return and exit the OSD menu (or let it time out).
 - o Test by sending temporary power (12v +) to the **green wire** labeled reverse.

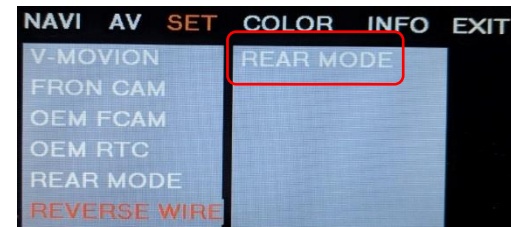
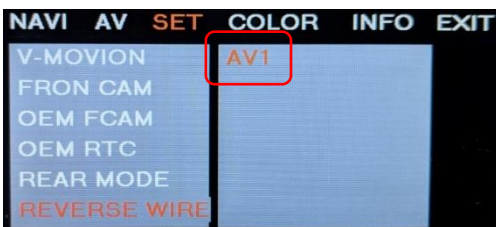

AV1 shows the 'AVIN' RCA when the green reverse wire is triggered.

REAR shows the 'CAMERA' RCA (with no lines) when the green reverse wire is triggered

REAR MODE shows the 'CAMERA' RCA (with dynamic lines) when the green reverse wire is triggered.

BMW12-N Installation Diagram

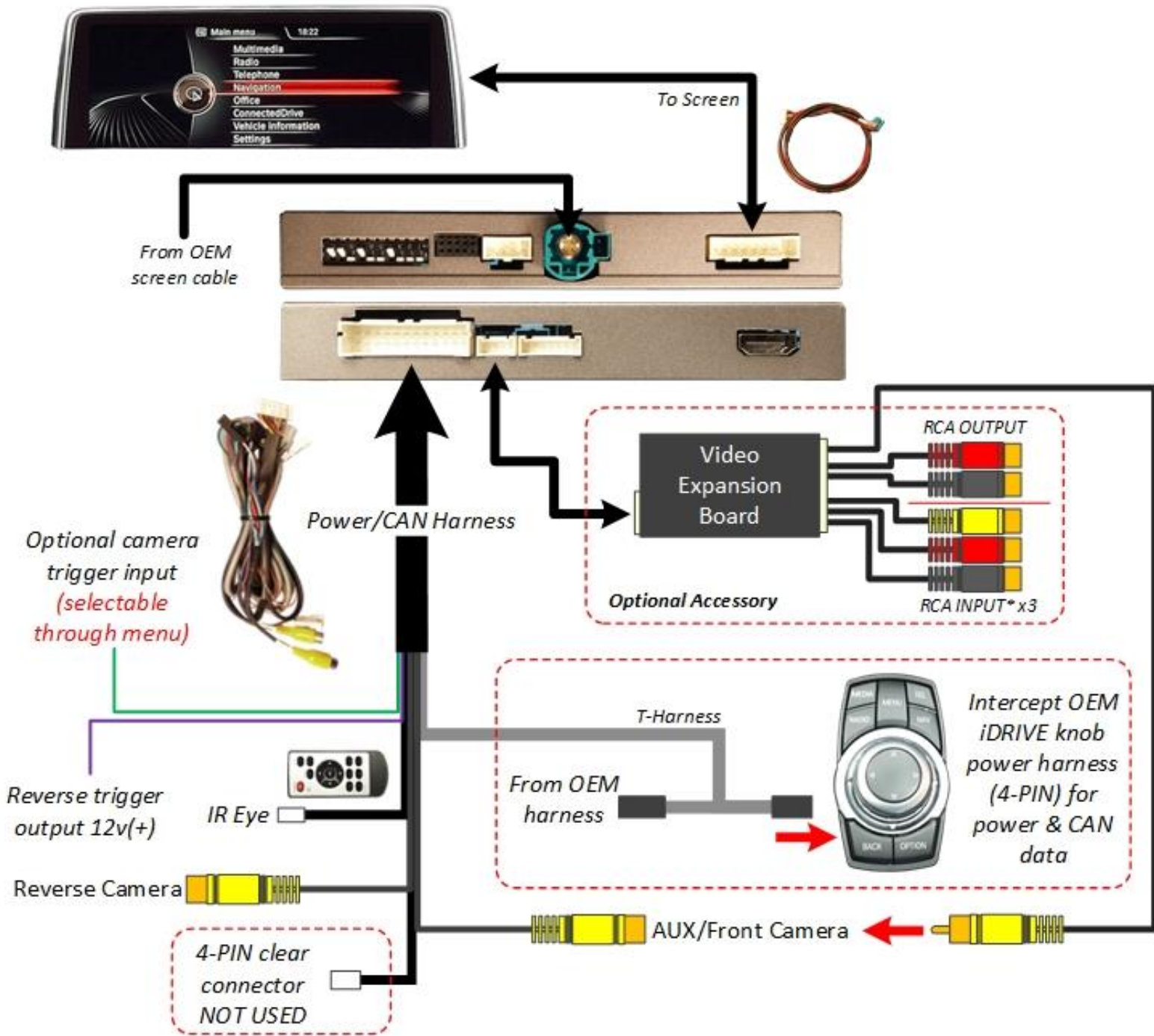

Agreement: End user agrees to use this product in compliance with all State and Federal laws. NAV-TV Corp. would not be held liable for misuse of its product. If you do not agree, please discontinue use immediately and return product to place of purchase. This product is intended for off-road use and passenger entertainment only.

BMW12-N Operation

- Once all connections are made and dip switches are set properly, placing the vehicle in reverse will display the connected camera with dynamic guidelines for convenience*.
- Additionally, see below for AUX/Front camera activation using factory buttons.



Hold (3 sec): Activate AUX/Front Camera video input

Hold (3 sec): Change AUX/Front Camera view (60/40 split, etc)

Hold (3 sec) WHEN IN REVERSE: in most vehicles, Change Rear Camera view (60/40 split, etc)

Hold (3 sec) WHEN IN REVERSE: in a few vehicles, Change Rear Camera view (60/40 split, etc)

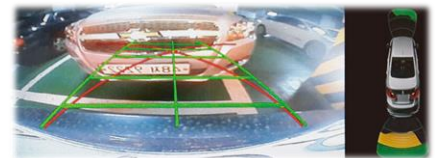

**NOTE: Some lower end 1 and 3-series vehicles steering wheel data is not present, therefore the parking lines may not turn with the wheel.*

Agreement: End user agrees to use this product in compliance with all State and Federal laws. NAV-TV Corp. would not be held liable for misuse of its product. If you do not agree, please discontinue use immediately and return product to place of purchase. This product is intended for off-road use and passenger entertainment only.

Problem: When I connect power to the unit, I lose the factory screen image.

Solutions:

1. Verify that this kit is compatible with your vehicle, see cover page for photos of compatible screen menus.
 2. Flip Dip switch #9 to the opposite position.
 3. If steps 1 or 2 did not resolve the problem, and unplugging the power/CAN connector for the unit did not restore the factory image to the screen, please disconnect the vehicle battery for 1 minute to reset the system.
 4. Confirm the factory screen is displaying properly with Power/CAN unplugged but the LVDS cables connected. If not, suspect reversed LVDS connections, Bad LVDS cables or a defective unit.
-

Problem: I am adding an aftermarket Rear View Camera but the screen does not change to the camera when in reverse

Solutions:

1. Verify Power and Ground to the interface, Confirm inline fuse (in fuse holder) is intact and seated properly.
 2. Make sure Dip switch #4 is DOWN
 3. If the vehicle is equipped with a manual transmission, the green reverse trigger wire (to +12V) must be used.
 4. Try switching dip switch #5 down or dip switch #6 down (but not both down) - power cycle and retest.
 5. If the vehicle is an Automatic transmission Mini Cooper, try dip switch #7 down.
 6. Verify Doors and trunk lid are all closed.
 7. Refer to page 8, Make sure that the menu item "REAR MODE" is set to ON.
 8. Suspect defective unit.
-

Problem: I am adding an aftermarket Rear View Camera but the screen switches to black or black with parking lines when in reverse

Solutions:

1. If Parking lines are present, Video signal is not present at the CAM RCA input - verify video signal with a known working source. Possible causes would be bad camera, broken video cable from camera, no power / ground at the camera terminals.
 2. If parking lines are not present and the screen is fully black when in reverse, suspect reversed LVDS connections.
 3. Suspect defective wiring or defective unit.
-

Problem: When triggered, I can see a rolling or scrolling camera image.

Solutions:

1. Backup camera problem - double check Power and Ground to the camera, replace camera.
-

Problem: I can see a backup camera image but no Parking lines are visible

Solutions:

1. Set dip switch #8 down
 2. Refer to Page 7, Make sure "FPG" is set to ON.
-

Problem: My vehicle has a factory rear view camera, I am adding a front camera or an AUX video source and I lost my Factory RVC when in reverse

Solutions:

1. Set dip switch #4 UP
-

Problem: Preset #3 on my radio brings up the front camera or AV Source

Solutions:

1. This is normal and is designed in case of FM Modulators used in combination with an Auxiliary Video source, Program the FM modulator frequency to preset #3 and use this preset as a shortcut to both Audio and Video selection. Please note that selecting preset #3 via the steering wheel would not bring up the video source.
-

Problem: When I hold the Menu or press the MAP/NAV button, I get a message "GPS No signal" on a black background

Solutions:

1. Set Dip switch #1 up.