

NAV-TV

INTERFACING THE FUTURE

3950 NW 120th Ave, Coral Springs, FL 33065 TEL 561-955-9770 FAX 561-955-9760

www.nav-tv.com info@nav-tv.com

BMW56-N DYNAMIC KIT

NTV-KIT724



Screen Connector



Quick Reference
(LVDS) Video Cable connects at Screen
Power/CAN Harness connects at Screen
Unit requires Constant 12v
Do not power camera with reverse light. Use ACC or purple wire (through relay)

Overview

The BMW56-N kit interfaces 2 video inputs (including a backup camera) to the factory media screen in select '04-'08 BMWs. This kit connects behind the screen and is not plug & play at this time.

Kit Content

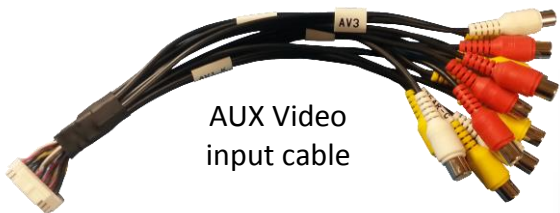

AUX Video input cable



BMW56-N Interface
NTV-INT245



LVDS Video cable



Remote
(menu control)



Rear Camera Cable

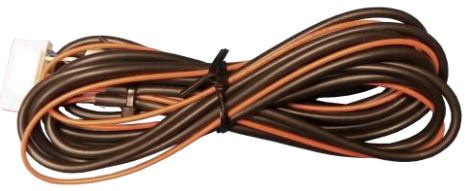

Power/CAN Harness



IR receiver cable

Agreement: End user agrees to use this product in compliance with all State and Federal laws. NAV-TV Corp. would not be held liable for misuse of its product. If you do not agree, please discontinue use immediately and return product to place of purchase. This product is intended for off-road use and passenger entertainment only.

Interface Connectors

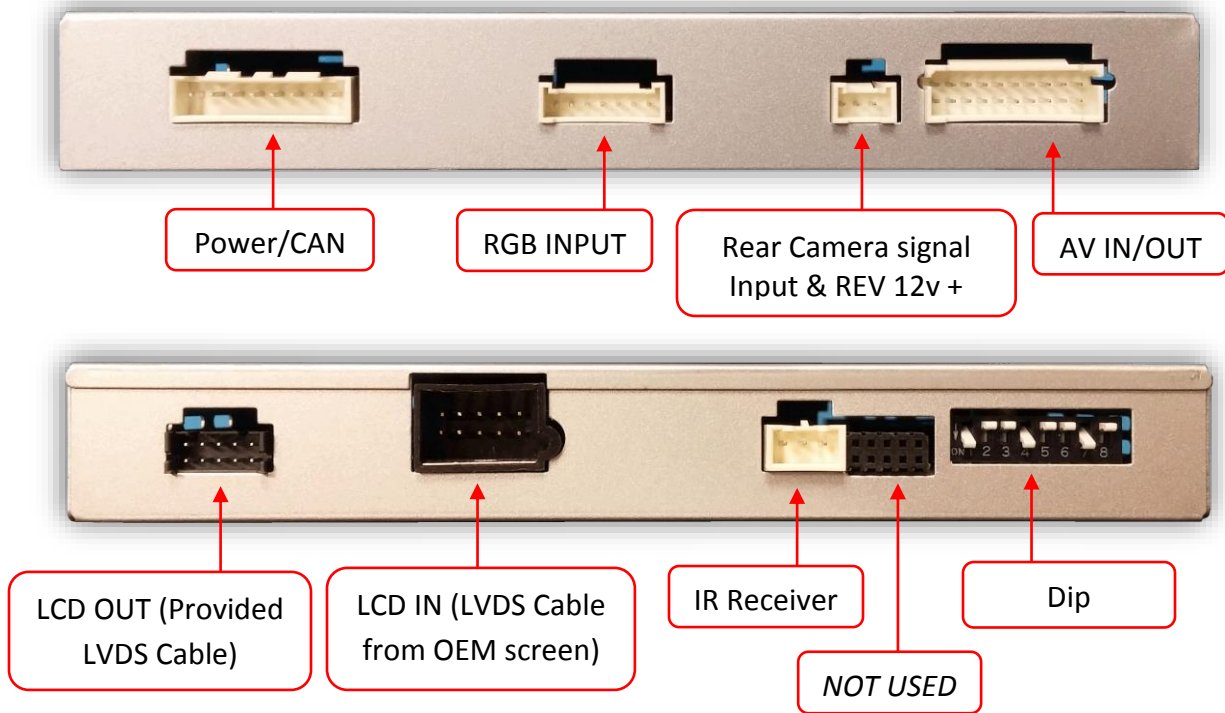

Dip Switch Settings*

Dip SW:	1	2	3	4	5	6	7	8
UP	KEEP UP	SKIPS V1	SKIPS V2	RVC OFF	VEH SETTING	VEH SETTING	VEH SETTING	VEH SETTING
DOWN	KEEP UP	ENABLES V1	ENABLES V2	RVC ON	VEH SETTING	VEH SETTING	VEH SETTING	VEH SETTING



8.8" screen V1

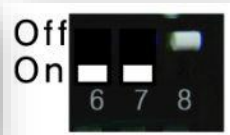

8.8" screen V2



8.8" screen V3

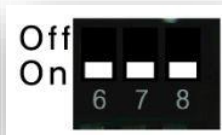

6.5" screen



8.8" screen
X6, 5 series



3 series

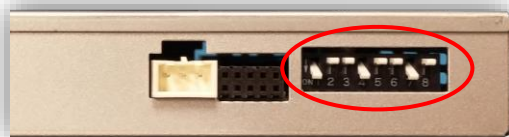

*Note: after adjusting Dip Switches, you must disconnect and reconnect power to the interface or the change will not be implemented.

Agreement: End user agrees to use this product in compliance with all State and Federal laws. NAV-TV Corp. would not be held liable for misuse of its product. If you do not agree, please discontinue use immediately and return product to place of purchase. This product is intended for off-road use and passenger entertainment only.

BMW56-N Installation

1. The BMW56-N connects entirely behind the **OEM infotainment screen**. You must gain access behind the screen for proper connection.
 - a. Remove any dash panels secured to the sub-dash to access the Torx screws which secure the screen. Remove the screen and set aside.
2. Connect (splice) the following (4) wires from the provided *Power/CAN Harness* to the OEM 12-PIN screen power harness (previously removed from the screen in step 1):



Interface wire	Description	Connect to BMW PIN
Black	Ground (-)	3
Red	12v (+)	1
Blue	CAN HIGH	5*
White	CAN LOW	6*
Orange	<i>NOT USED – CUT & INSULATE</i>	
Green	<i>Optional Camera trigger input 12v + (selectable via menu)</i>	

**NOTE: if reverse switching does not operate properly, swap CAN wire connection.*

3. Connect the provided LVDS video cable to the port on the BMW56-N interface labeled 'LVDS OUT' and the other end back to the screen at the LVDS port.



4. Connect the OEM LVDS video cable (originally connected to the screen) to the port on the BMW56-N interface labeled 'LCD IN'.



5. Connect the provided *Rear Camera Cable* to the interface at the port labeled 'CAM'.
6. Install and run the reverse camera power and signal to the BMW56-N interface location and connect to the RCA labeled 'CAMERA'. Power your camera with an ACC source or use the **yellow wire** for reverse 12v (+) only located on the *Rear Camera cable*. *NOTE: this wire outputs 500 mA MAX – do not use to supply power to more than 1 camera. Use this wire to trigger a relay if you're concerned with current supply.*
7. **Optional:** If connecting additional AUX video sources, connect the AV Harness to the interface port labeled 'AV IN/OUT' and use 'AV1' or 'AV2' RCAs for video input signals. *Make sure the DIP switch settings are set properly if using additional video inputs.*



8. After DIP switch settings have been set (see page 2), connect the 8-PIN power connector to the BMW56-N interface labeled 'POWER CAN'. Proceed to **BMW56-N Operation**.

Agreement: End user agrees to use this product in compliance with all State and Federal laws. NAV-TV Corp. would not be held liable for misuse of its product. If you do not agree, please discontinue use immediately and return product to place of purchase. This product is intended for off-road use and passenger entertainment only.

BMW56-N Install Diagram

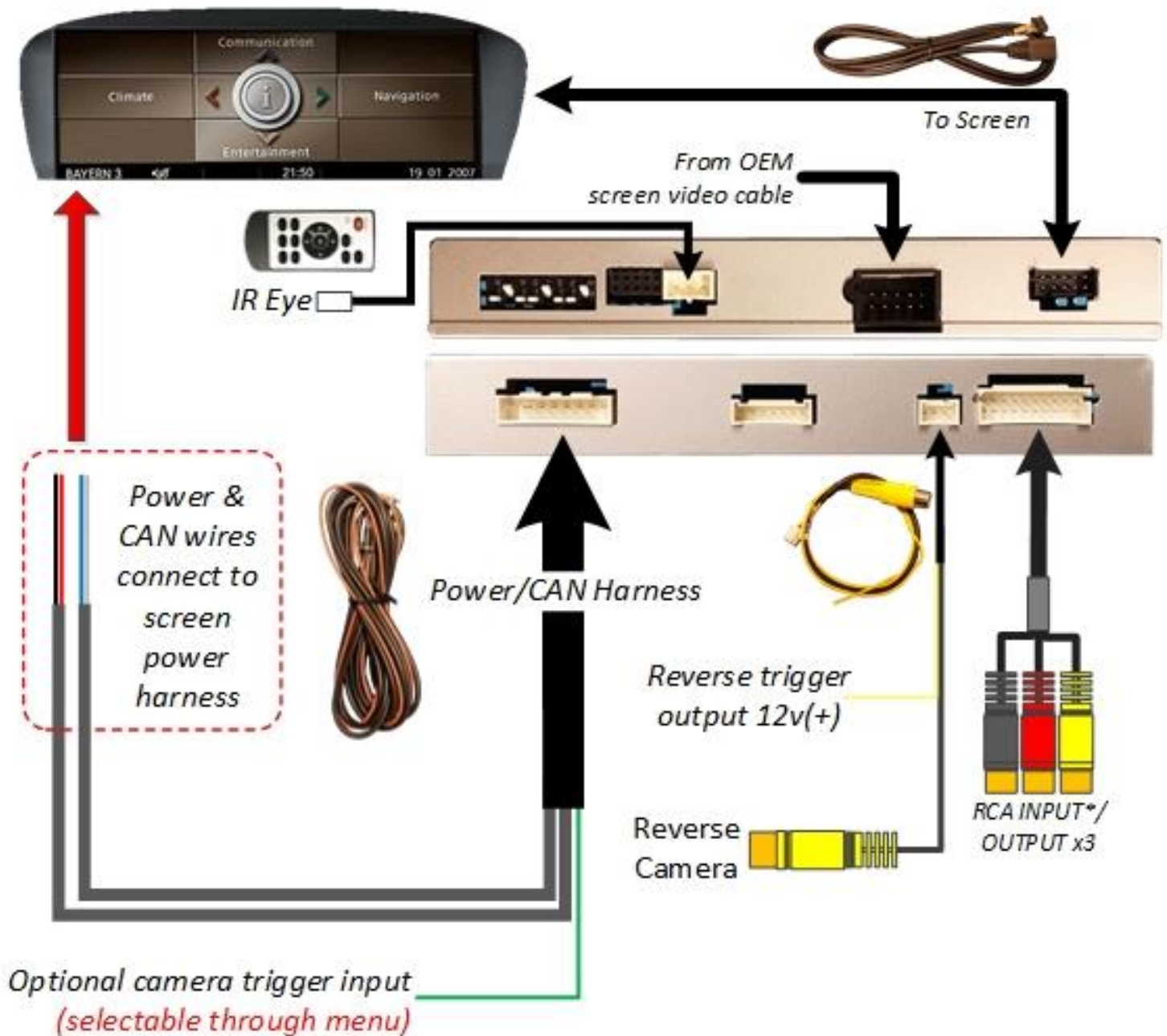

**RCA signal integration for video only. Audio input is only pass through if supplied and switching follows video switch.*

Agreement: End user agrees to use this product in compliance with all State and Federal laws. NAV-TV Corp. would not be held liable for misuse of its product. If you do not agree, please discontinue use immediately and return product to place of purchase. This product is intended for off-road use and passenger entertainment only.

Green Trigger wire setup

This module includes a green *input* wire for analog triggering of either the Reverse camera input or the 'AVIN' input (yellow RCAs), selectable through the AV menu. This allows for adding multiple cameras through the use of an SVS-6 switcher, etc. Follow the steps below adjust this feature. *NOTE: by default, the green wire will trigger the Reverse camera input RCA.*

1. Put dip switch #1 in the **DOWN** position. When this section is complete, return switch #1 **UP**.
2. Activate the 'NAV INPUT' by **holding** the 'MENU' button on the iDRIVE knob.
3. Once 'NAV INPUT' shows on the screen, on the remote press the **OK BUTTON 4 times**, then press **POWER**.
4. Navigate to the 'SET' section.
 - Select 'REVERSE WIRE'
 - Choose 'AV1', 'REAR' or 'REAR MODE' (explanations below)
 - Press **MODE** on the remote to return and exit the OSD menu (or let it time out).
 - Test by sending temporary power (12v +) to the **green wire** labeled *reverse*.

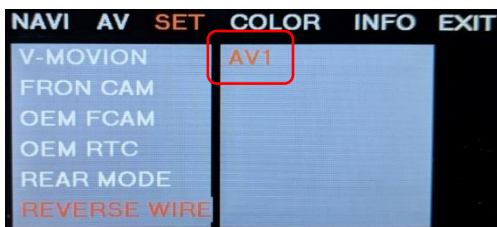

AV1 shows the 'AVIN' RCA when the green reverse wire is triggered.



REAR shows the 'CAMERA' RCA (with no lines) when the green reverse wire is triggered.

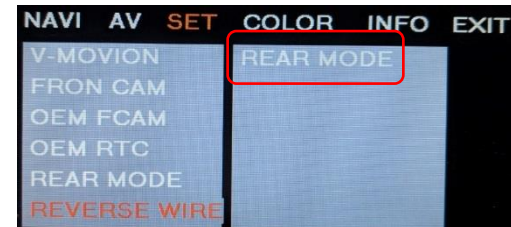

REAR MODE shows the 'CAMERA' RCA (with dynamic lines) when the green reverse wire is triggered.

BMW56-N Operation

- Once all connections are made and dip switches are set properly, placing the vehicle in reverse will display the connected camera with dynamic guidelines for convenience.
- Additionally, see below for AUX/Front camera activation using factory buttons.

Steering wheel



Hold (3 sec): Adjust PIP on Reverse Cam image or AUX Video image

Hold (3 sec): Cycle between AUX video and OEM screen

OR

iDRIVE knob



Hold (3 sec): Cycle between AUX video and OEM screen

Agreement: End user agrees to use this product in compliance with all State and Federal laws. NAV-TV Corp. would not be held liable for misuse of its product. If you do not agree, please discontinue use immediately and return product to place of purchase. This product is intended for off-road use and passenger entertainment only.