

NAV-TV

INTERFACING THE FUTURE

BHM
07/03/18
NTV-DOC325

3950 NW 120th Ave, Coral Springs, FL 33065 TEL 561-955-9770 FAX 561-955-9760

www.nav-tv.com info@nav-tv.com

GVIF-LEX18

NTV-KIT883



Quick Reference
(GVIF) Video Cables connect at Radio & Screen (OEM GVIF cable not utilized)
Power/CAN T-Harness connects at Radio & Screen Unit requires Constant 12v
Do not power camera with reverse light. Use ACC or purple wire (through relay)

Overview

The GVIF-LEX18 Kit interfaces 2 composite video inputs (including backup camera input) and an HDMI input (if desired) to the factory media screen in select 2018 Lexus vehicles. Installation is performed behind the radio (CD player) and screen.

Kit Content

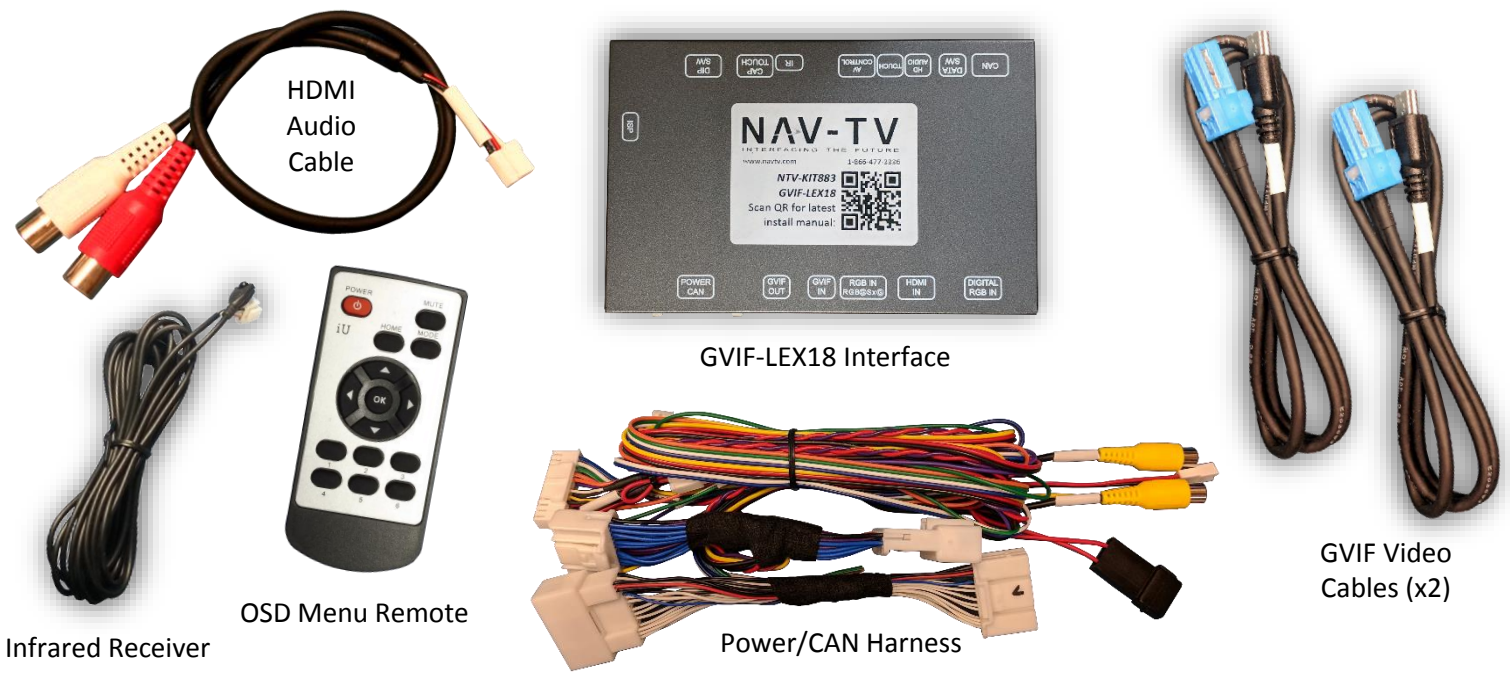

HDMI Audio Cable

Infrared Receiver

OSD Menu Remote

GVIF-LEX18 Interface

Power/CAN Harness

GVIF Video Cables (x2)

Agreement: End user agrees to use this product in compliance with all State and Federal laws. NAV-TV Corp. would not be held liable for misuse of its product. If you do not agree, please discontinue use immediately and return product to place of purchase. This product is intended for off-road use and passenger entertainment only.

Interface Connectors

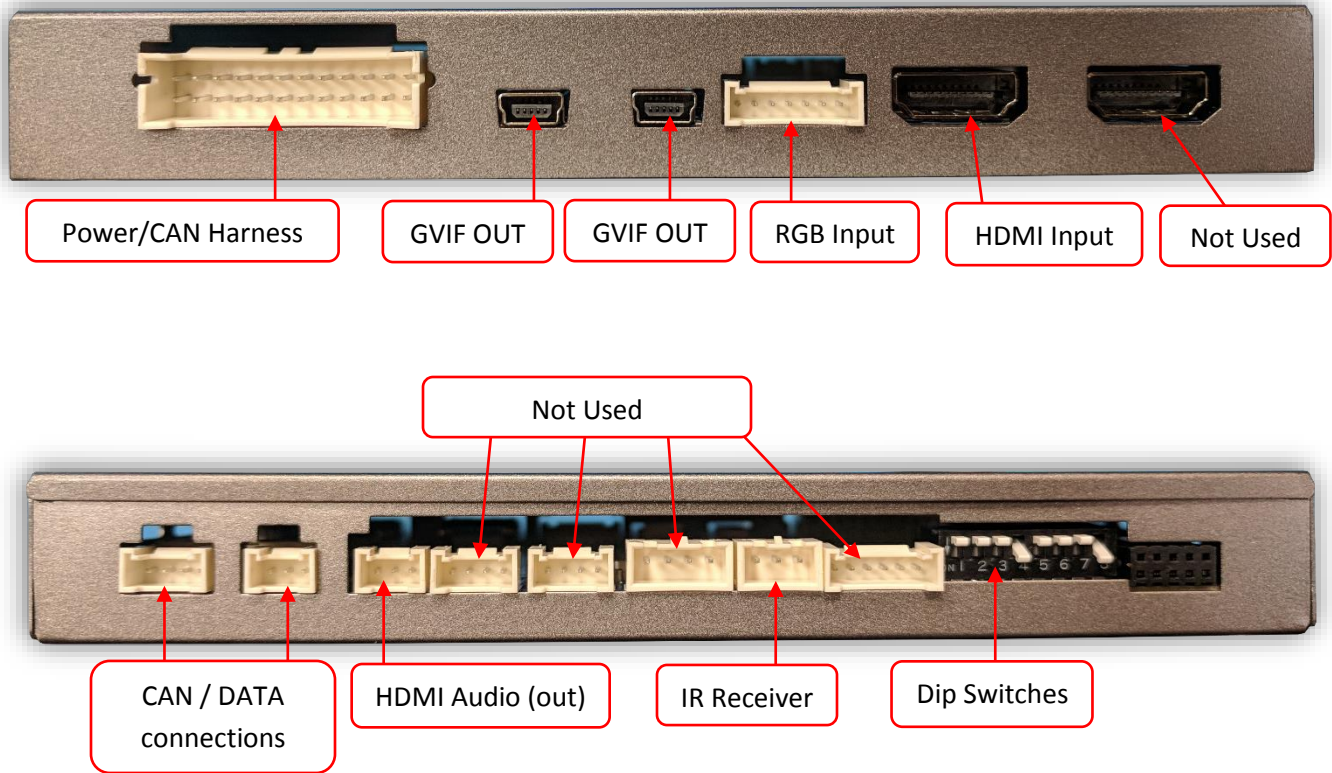

Dip Switch Settings

Dip SW:	1	2	3	4	5	6	7	8
UP	NORMAL OP	KEEP UP	KEEP UP	OEM REAR CAMERA	KEEP UP	RES SETTING	RES SETTING	KEEP DOWN
DOWN	Enter MENU	KEEP UP	KEEP UP	ADDING REAR CAMERA	KEEP UP	RES SETTING	RES SETTING	KEEP DOWN



Note: Remove power to the unit prior to making adjustments to the dip switches.

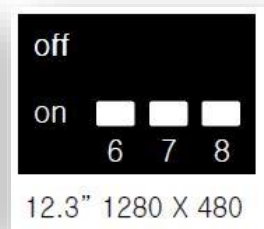
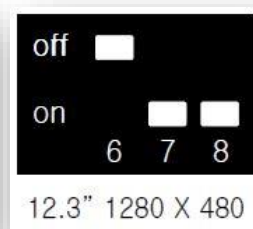
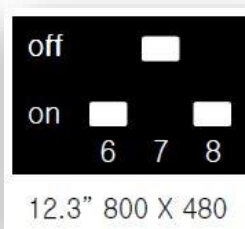
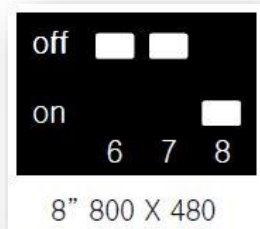

TYPE 1

TYPE 2

Agreement: End user agrees to use this product in compliance with all State and Federal laws. NAV-TV Corp. would not be held liable for misuse of its product. If you do not agree, please discontinue use immediately and return product to place of purchase. This product is intended for off-road use and passenger entertainment only.

Installation

1. Remove the radio (CD player) and screen from the dashboard.
2. Connect the provided 30-PIN *Plug & Play T-Harness* in **between the vehicle harness and the radio** using the proper OEM plug (this T-Harness will only connect one way and to one connector).
3. Connect the provided 24-PIN *Plug & Play T-Harness* in **between the vehicle power harness and the screen**.
4. Connect the remaining 24-PIN power plug from the T-Harness to the port on the interface labeled **'POWER CAN'**.
5. Connect the 3-PIN and 4-PIN plugs among the T-Harness to the interfaces' **'CAN'** and **'DATA SW'** ports.

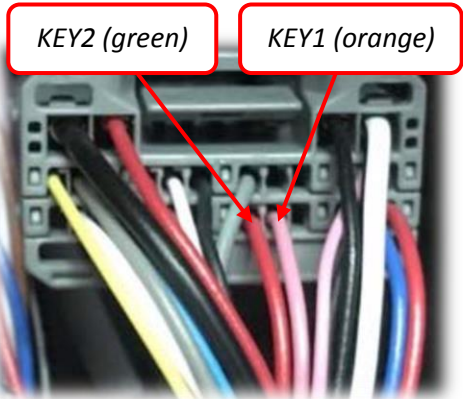
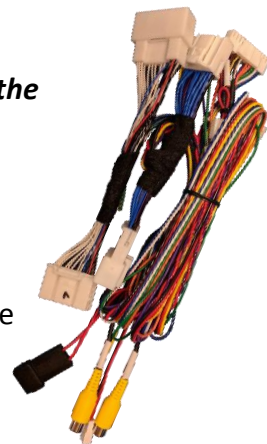

6. From the provided *T-Harness*, tap (2x) OEM radio CAN wires with the **orange** and **green** wires labeled **KEY1** and **KEY2**. This connection is required if using the OEM steering wheel button for forced switching. See picture (right) for specific connection location (24-PIN gray radio plug):

Interface wire	Radio plug wire
KEY 1 (orange)	PINK
KEY 2 (orange)	RED

7. **Optional:** if connecting an HDMI source, connect now to the **'HDMI IN'** port. Use the provided **'HDMI Audio Cable'** for audio OUT from the HDMI source. Run (extend) this pair of RCAs to the AUX-input of the vehicle if audio from the HDMI source is required (if phone screen mirroring, using BT is an option as well).



8. Connect the provided (male) **'GVIF-OUT Cable'** from **GVIF-OUT** (interface), directly to the monitor.
9. Connect the 2nd provided (male) **'GVIF-IN Cable'** from **GVIF-IN** (interface), directly to the radio's GVIF port. **NOTE: the OEM GVIF cable will not be used.**



10. Reconnect remaining OEM plugs to radio/screen and proceed to **'Operation'** for testing.

NOTE: no other plugs or harnesses among the T-Harness or provided are required for this install.

Agreement: End user agrees to use this product in compliance with all State and Federal laws. NAV-TV Corp. would not be held liable for misuse of its product. If you do not agree, please discontinue use immediately and return product to place of purchase. This product is intended for off-road use and passenger entertainment only.

GVIF-LEX18 Install Diagram

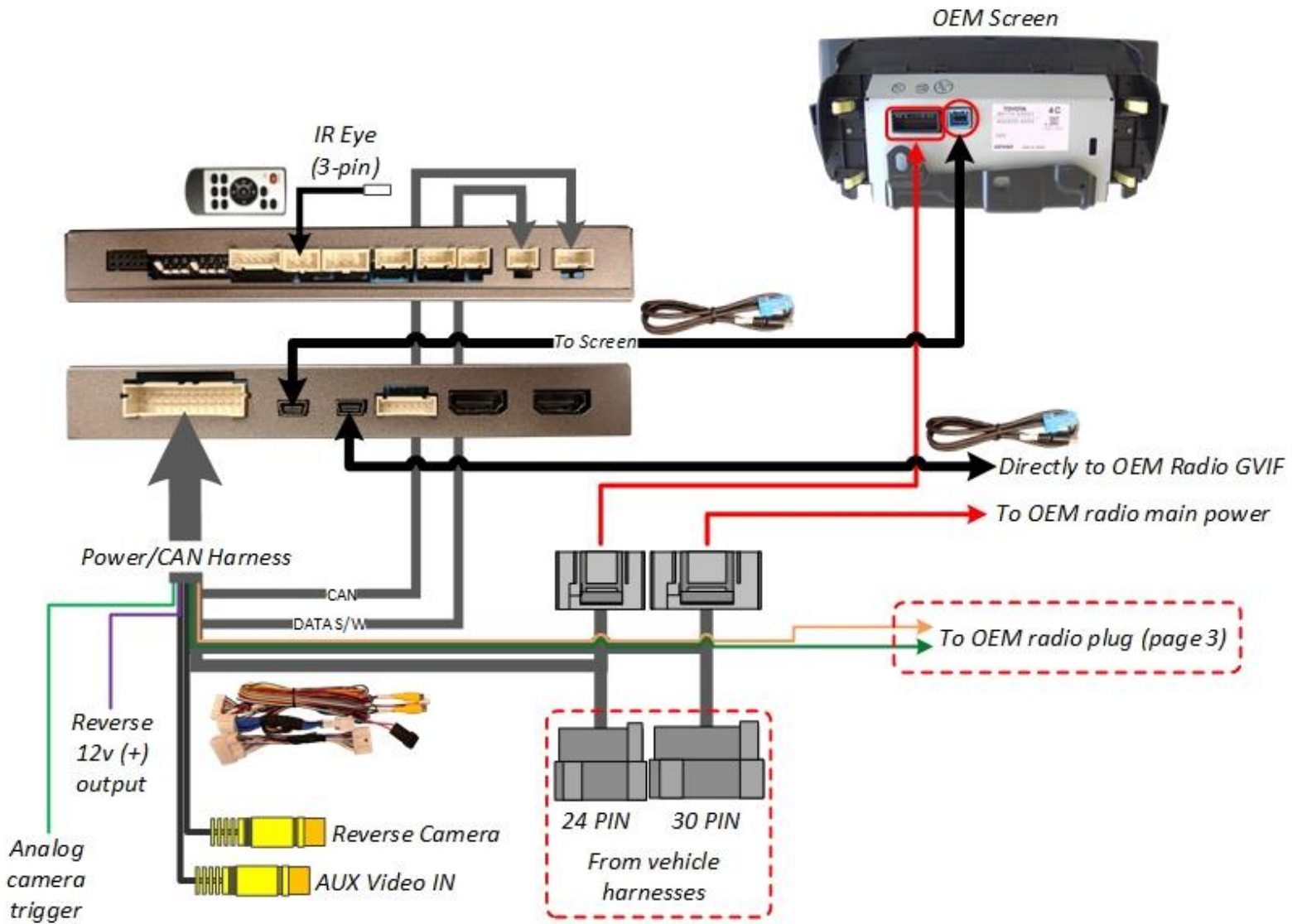

Agreement: End user agrees to use this product in compliance with all State and Federal laws. NAV-TV Corp. would not be held liable for misuse of its product. If you do not agree, please discontinue use immediately and return product to place of purchase. This product is intended for off-road use and passenger entertainment only.

GVIF-LEX18 Menu Adjustments

Before you start:

- The IR-Eye must be connected to the interface
- Make sure the car's ignition is on and radio is on
- You must be in **Reverse Camera** mode.
 - **Reverse Camera Mode** adjusts Reverse Camera Settings
- Press the **OK BUTTON** 4 times (numbers will display per press), then press **POWER**.
- The **OSD Menu** will appear on screen (auto-time out in about 5 seconds if no action occurs).



Reverse Menu

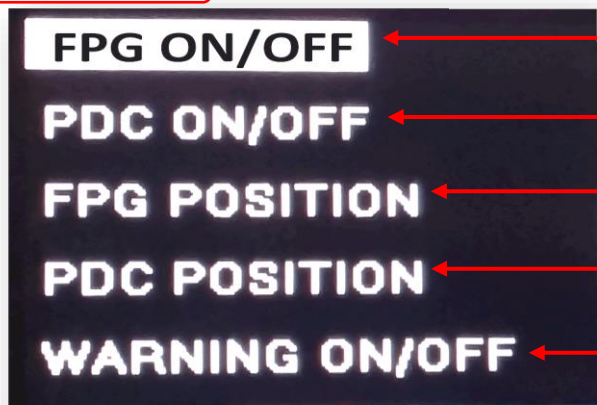

Functional Parking Guidelines ON/OFF

Parking Distance Control ON/OFF (while in reverse)

Adjust FPG Position

Adjust PDC Position

'Safe to move?' ON/OFF

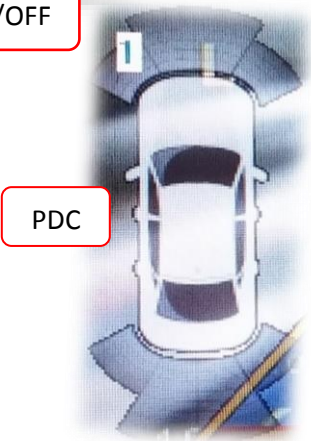

AUX Video Menu

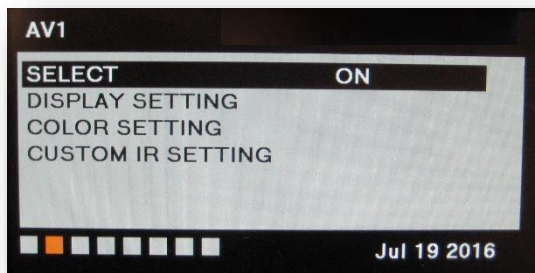

If adding a front camera OR Aux Video source:

1. Disconnect POWER/CAN Harness from interface
2. Place DIP SWITCH 1 in the DOWN position, reconnect power
3. Press and hold the **back-arrow** button at the jog control to activate 'NAVI' screen
4. Press **OK** button on remote 4 times, then press **POWER**

If the user wants only an AUX video input **without front camera**, set **AV1 SELECT** to **ON**, scroll to the end (right side) of the menu and exit menu.

FRONT CAMERA setting is used when **the user wants automatic front camera switching**. Options for 5, 7, 9 or 11 seconds are user-selectable for the length of time the front camera input stays active once the vehicle is placed out of reverse.

Once finished with settings, place DIP SWITCH 1 back into the **UP position** and reset power to interface (if this step is not taken, the unused 'NAVI' input will show as an additional video input when cycling video inputs)

Agreement: End user agrees to use this product in compliance with all State and Federal laws. NAV-TV Corp. would not be held liable for misuse of its product. If you do not agree, please discontinue use immediately and return product to place of purchase. This product is intended for off-road use and passenger entertainment only.

HDMI Setup

In order to use the HDMI feature of this kit, it must be setup via the OSD menu first.



1. Put dip switch #1 in the **DOWN** position.
2. Activate the 'NAV INPUT' by holding the **Back-button** at the OEM touch pad.
3. Once 'NAV INPUT' shows on the screen, on the remote press the **OK BUTTON 4 times**, then press **POWER**.
4. Navigate to the 'NAVI' section.
 - a. Select 'HDMI-SEL'
 - b. Choose 'HD95'
 - c. Press **MODE** on the remote to return
5. Navigate to the 'AV' section.
 - a. Select 'AV1-SEL'
 - b. Choose 'HDMI'
6. If the user desires **front camera timer**, set it up now through 'FRON CAM' under 'SET' and choose timer length. If adding front camera and no timer is desired, use DIP SWITCH #2 instead (only).
7. Replace dip switch #1 to the **UP** position.

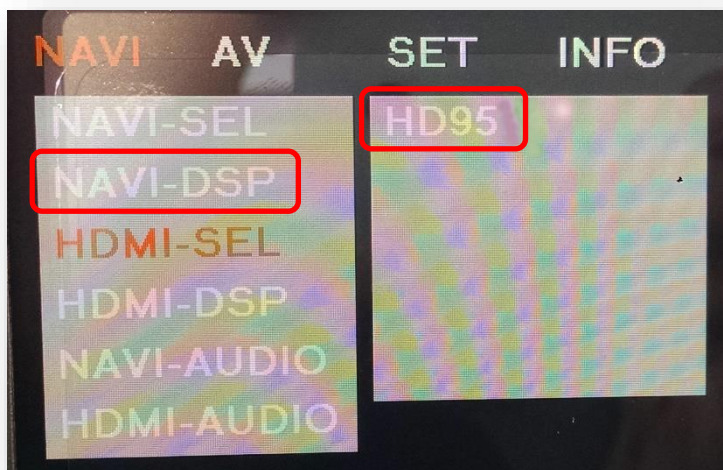

GVIF-LEX18 Operation

- Once all connections are made, placing the vehicle in reverse will display the connected camera image on the screen.
- Press and hold the **Back-arrow** button at the jog control to switch active video inputs.

