

NAV-TV

INTERFACING THE FUTURE

3950 NW 120th Ave, Coral Springs, FL 33065 TEL 561-955-9770 FAX 561-955-9760

www.nav-tv.com info@nav-tv.com

BHM
10/17/18
NTV-DOC290

BMW-EVO KIT

NTV-KIT804



Quick Reference
(LVDS) Video Cable connects at Screen
Power/CAN T-Harness connects at iDRIVE controller
Unit requires Constant 12v
Do not power camera with reverse light. Use ACC or purple wire (through relay)

Overview

The BMW-EVO kit interfaces 2 video inputs (including a backup camera) to the factory media screen in select 2017 BMWs with the **NEW GUI (NON-TOUCH SCREEN)**. This interface generates steering-based guidelines while in reverse for added convenience. *NOTE: the touch-screen models with this OEM system are not compatible.*

Kit Contents

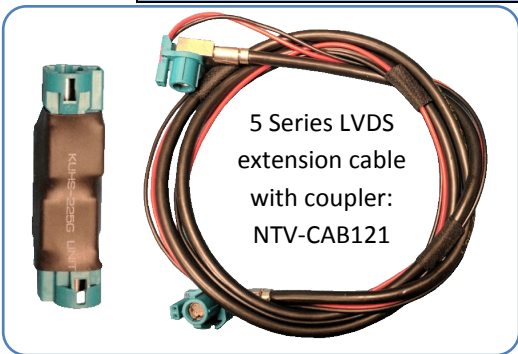

Optional extension cables



BMW-EVO Interface

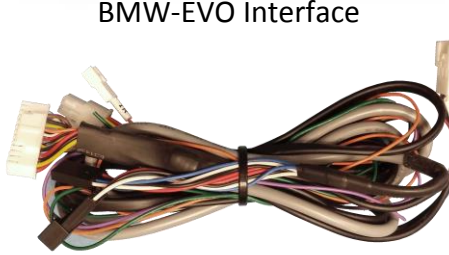
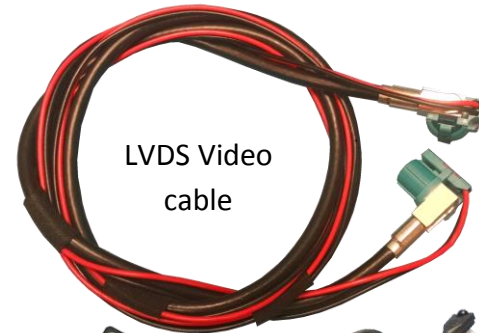

Power/CAN Harness



Remote (menu control)



IR Eye Harness

Agreement: End user agrees to use this product in compliance with all State and Federal laws. NAV-TV Corp. would not be held liable for misuse of its product. If you do not agree, please discontinue use immediately and return product to place of purchase. This product is intended for off-road use and passenger entertainment only.

Interface Connectors

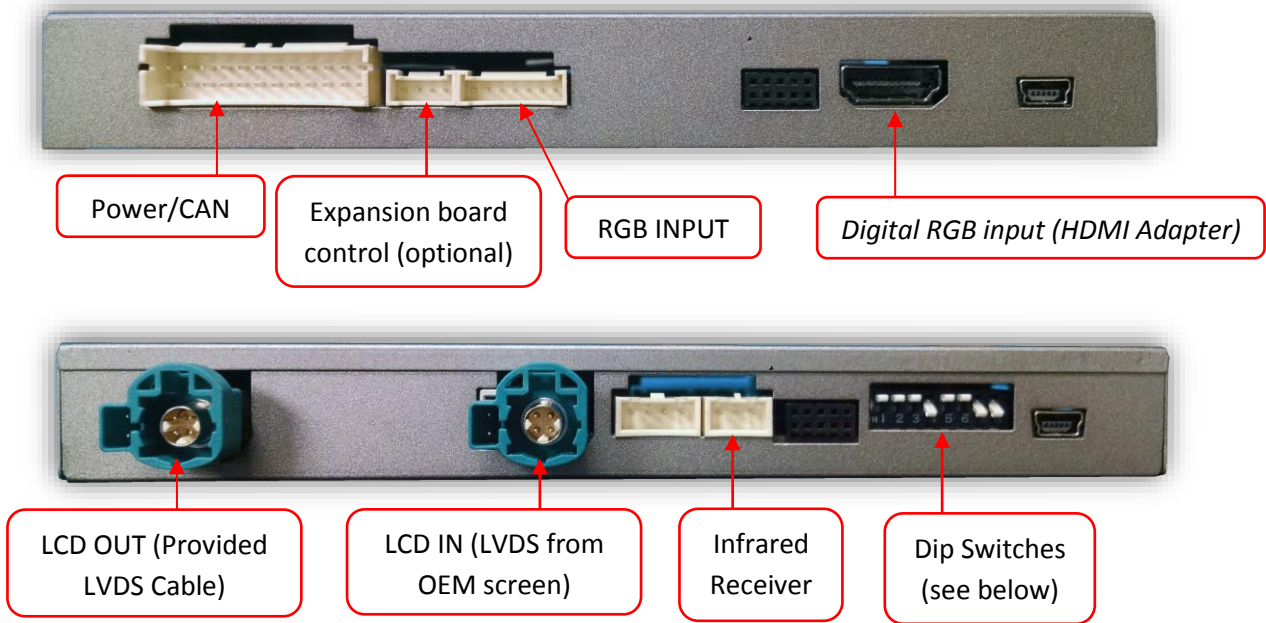

Dip Switch settings*

Dip SW:	1	2	3	4	5	6	7	8
UP	NO NAV	N/A	N/A	RVC OFF	N/A	N/A	KEEP DOWN	KEEP DOWN
DOWN	ADDING NAV	N/A	N/A	RVC ON	N/A	N/A	KEEP DOWN	KEEP DOWN

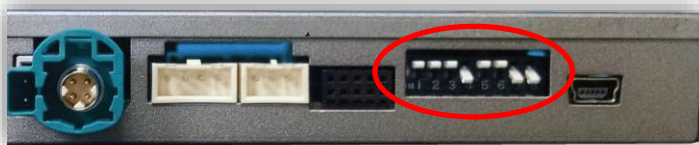

***Note: after adjusting Dip Switches, you must disconnect and reconnect power to the interface or the change will not be implemented.**

BMW-EVO Interface Installation (5 Series example)

1. The BMW-EVO intercepts **two OEM plugs in two locations**: the iDRIVE knob and the screen. You must gain access to both places for proper installation.
 - a. Access the rear of the screen by removing the dashboard panel (clips only) and then removing (2x) Torx T20 screws securing the screen to the sub-dash.



2. To access the iDrive harness, remove the panel surrounding it (may have Torx screw securing to sub dash)

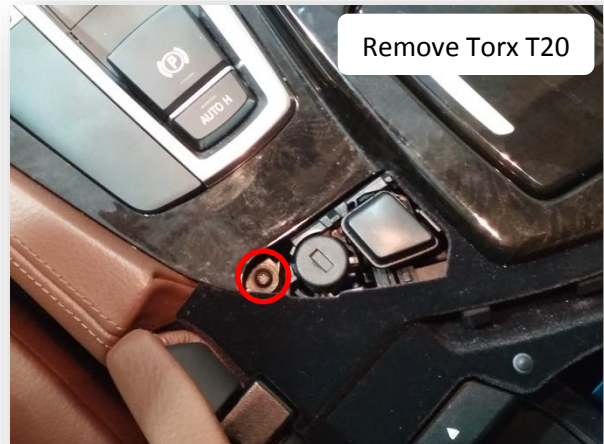
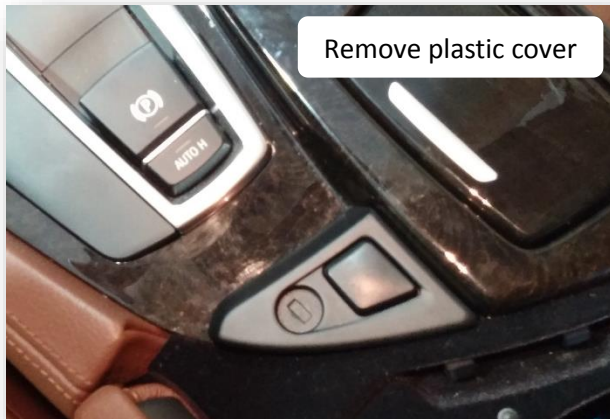

3. Lift up the lower dash panel and disconnect 4-PIN plug powering the iDrive knob.

4. Connect provided 4-PIN T-Harness in between iDrive knob and OEM harness as shown.

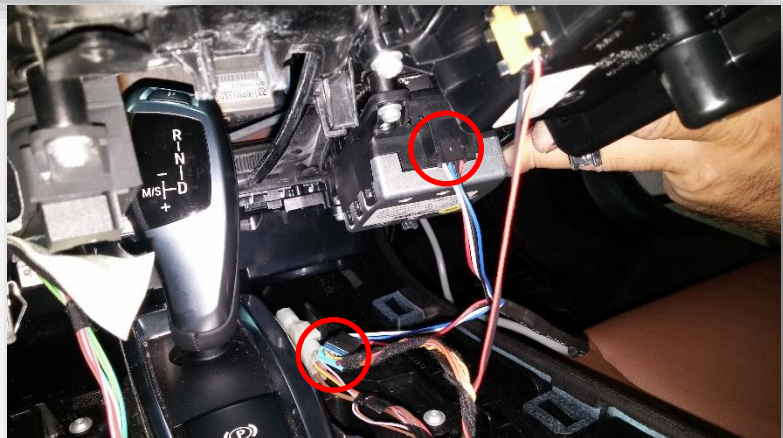

Agreement: End user agrees to use this product in compliance with all State and Federal laws. NAV-TV Corp. would not be held liable for misuse of its product. If you do not agree, please discontinue use immediately and return product to place of purchase. This product is intended for off-road use and passenger entertainment only.

4. Replace the lower dash panel (with iDrive knob) back to sub-dash.
5. Disconnect the OEM screen LVDS video cable and connect it to the port on the BMW12-N labeled 'LCD-IN'.



NOTE: If purchased (separately), use the LVDS extension cable (with coupler) from the OEM screen cable removed from the screen to the module for convenience.



OR

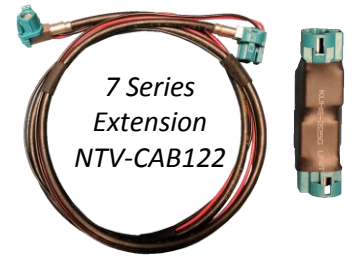

6. Connect the provided LVDS Video Cable to the port on the BMW12-N labeled 'LCD-OUT' and the other end back to the screen.



7. Install and run the reverse camera video source power and signal to the BMW-EVO interface location and connect to the RCA labeled 'CAMERA'. Power your camera with an ACC source or use the **violet wire** for reverse 12v (+) only. *NOTE: this wire outputs 500 mA MAX – do not use to supply power to more than 1 camera. Use this wire to trigger a relay if you're concerned with current supply.*

8. **Optional:** If installing a secondary camera or AUX video source, connect signal RCA to the RCA on the BMW-EVO interface labeled 'AVIN'.

7. After DIP switch settings have been set (see page 2), connect the 24-PIN power connector to the BMW-EVO interface labeled 'POWER CAN'. Proceed to **Menu Options** section if necessary (front camera settings, etc) or to **BMW-EVO Operation**.

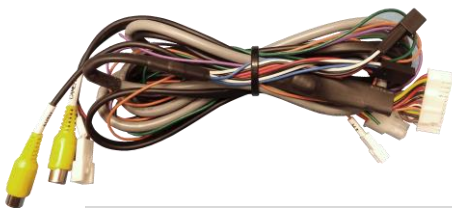

Agreement: End user agrees to use this product in compliance with all State and Federal laws. NAV-TV Corp. would not be held liable for misuse of its product. If you do not agree, please discontinue use immediately and return product to place of purchase. This product is intended for off-road use and passenger entertainment only.

Menu Adjustments

Before you start:

- The IR-Eye must be connected
- Make sure the car's ignition is on and radio is on
- You must be in **Reverse Camera** mode **OR** **AUX Video** mode (see below):
 - **Reverse Camera Mode** adjusts Reverse Camera Settings
 - **AUX Video Mode** adjusts AUX Video Settings
- Press the **OK BUTTON 4 times** (numbers will display per press), then press **POWER**.
- The **OSD Menu** will appear on screen (auto-time out in about 5 seconds if no action occurs).



Return
(AUX VID
menu
control)

RVC Menu

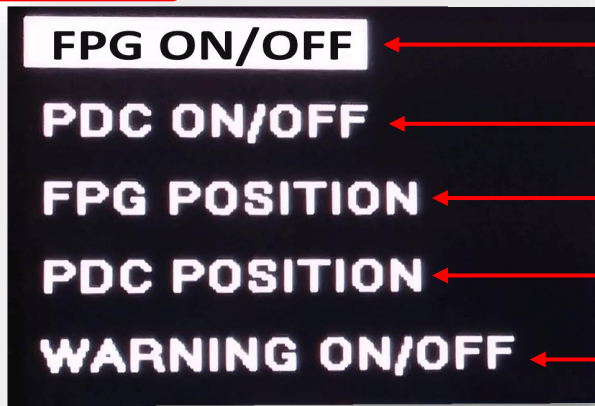

Functional Parking Guidelines ON/OFF

Parking Distance Control
ON/OFF (while in reverse)

Adjust FPG Position

Adjust PDC Position

'Safe to move?' ON/OFF

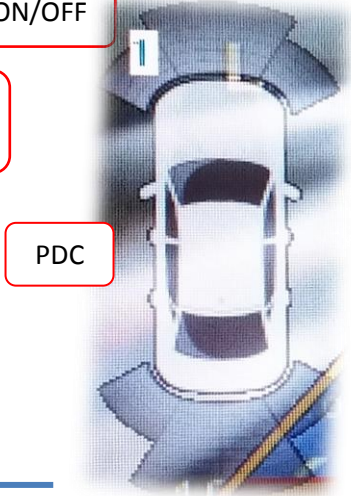

If adding a front camera OR Aux Video source:

1. Disconnect POWER/CAN Harness from interface
2. Place DIP SWITCH 1 in the DOWN position, reconnect power
3. Press and hold the iDRIVE knob '**MENU**' to activate the AUX screen
4. Press **OK** button on remote 4 times, then press **POWER**

If adding front camera and the user wants it timed (after leaving reverse), use **FRONT CAMERA** to set desired time.

If adding front camera or AUX video (no timer), set **AV1** to **ON** using the arrow keys on the remote (use 'UP' to change OFF to ON)

If adding HDMI Adapter, see next page.

Once finished with settings, place DIP SWITCH 1 back into the UP position and reset power to interface.

AUX
VIDEO
Menu

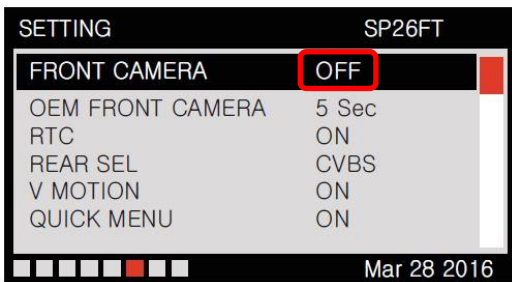

Agreement: End user agrees to use this product in compliance with all State and Federal laws. NAV-TV Corp. would not be held liable for misuse of its product. If you do not agree, please discontinue use immediately and return product to place of purchase. This product is intended for off-road use and passenger entertainment only.

Adding Optional HD-LINK Adapter (HDMI Input)

Follow the instructions below when adding the HDMI adapter (HD-LINK) to enable HDMI input to the OEM screen:



1. Put dip switch #1 in the **DOWN** position.
2. Activate the 'NAV INPUT' by pressing the 'MENU' button (iDRIVE knob)
3. Once 'NAV INPUT' shows on the screen, on the remote press the **OK BUTTON 4 times**, then press **POWER**.
4. Navigate to the 'HDMI' section.
 - a. Select 'OFF'
 - b. Choose 'HD95E'
 - c. Press **MODE** on the remote to return and exit the OSD menu (or let it time out).
5. Replace dip switch #1 to the **UP** position.
6. Connect the **black wire** to ground (-) and the **red wire** to ACC power (+) from the main power connector on the **HD-LINK** adapter. The RCA's on this plug provide audio from the HDMI source. See page 8 for a connection diagram.

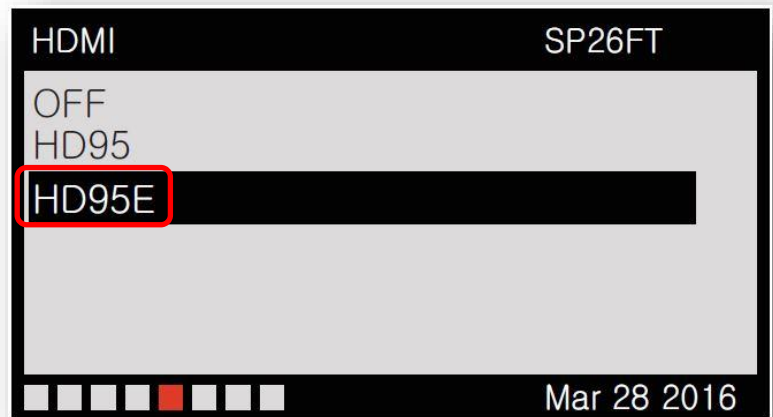
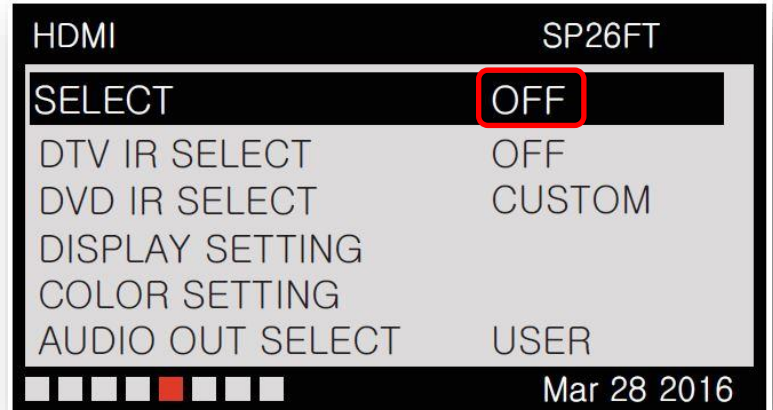

Green Trigger wire setup

This module includes a green *input* wire for analog triggering of either the Reverse camera input or the 'AVIN' input (yellow RCAs), selectable through the AV menu. This allows for adding multiple cameras through the use of an SVS-6 switcher, etc. Follow the steps below adjust this feature. *NOTE: by default, the green wire will trigger the Reverse camera input RCA.*

1. Put dip switch #1 in the **DOWN** position. When this section is complete, return switch #1 **UP**.
2. Activate the 'NAV INPUT' by **holding** the 'MENU' button on the iDRIVE knob.
3. Once 'NAV INPUT' shows on the screen, on the remote press the **OK BUTTON 4 times**, then press **POWER**.
4. Navigate to the 'SETTING' section (6 blocks over).
 - Select 'REVERSE WIRE'
 - Choose 'AV1', 'REAR' or 'REAR MODE' (explanations below)
 - Press **POWER** on the remote to return and exit the OSD menu (or let it time out).
 - Test by sending temporary power (12v +) to the **green wire** labeled reverse.

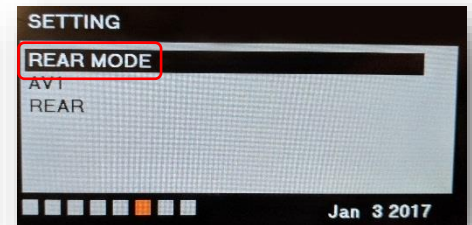
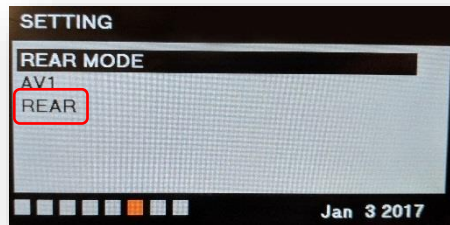
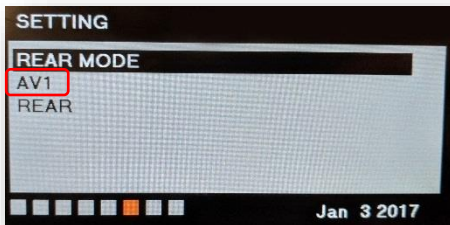
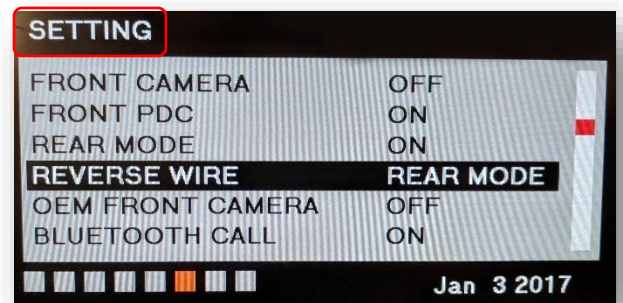

AV1 shows the 'AVIN' RCA when the green reverse wire is triggered.

REAR shows the 'CAMERA' RCA (with no lines) when the green reverse wire is triggered.

REAR MODE shows the 'CAMERA' RCA (with dynamic lines) when the green reverse wire is triggered.

BMW-EVO Installation Diagram

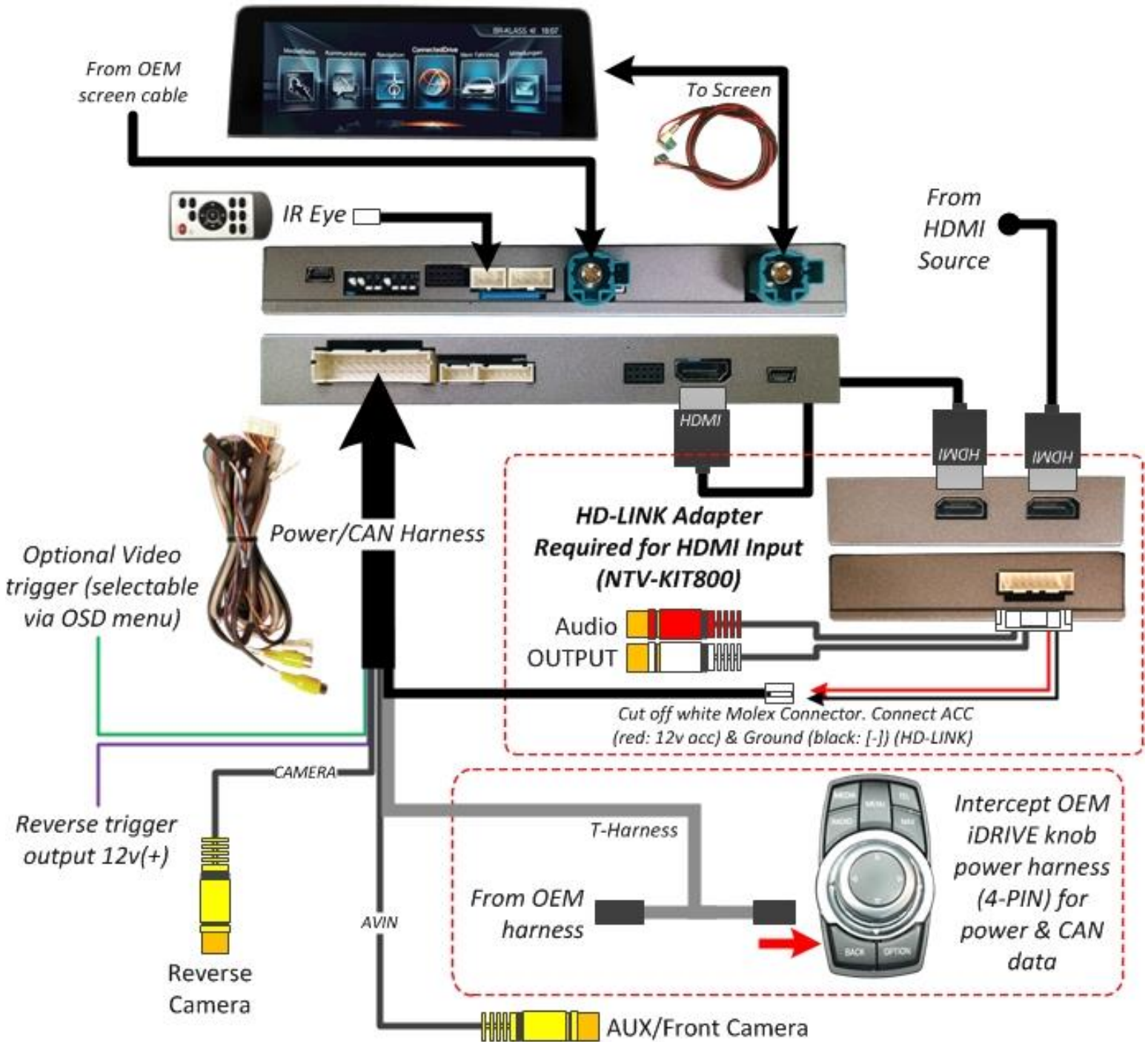

Agreement: End user agrees to use this product in compliance with all State and Federal laws. NAV-TV Corp. would not be held liable for misuse of its product. If you do not agree, please discontinue use immediately and return product to place of purchase. This product is intended for off-road use and passenger entertainment only.

BMW-EVO Operation

- Once all connections are made and dip switches are set properly, placing the vehicle in reverse will display the connected camera with dynamic guidelines for convenience.
- Additionally, see below for AUX/Front camera/HDMI activation using factory buttons.



Hold (3 sec): Activate
AUX/Front Camera
video input

Hold (3 sec): Change
AUX/Front Camera view
(60/40 split, etc)

**Hold (3 sec) WHEN
IN REVERSE:** 2013-
2015 3,5,7,X series:
Change Rear
Camera view
(60/40 split, etc)

**Hold (3 sec) WHEN IN
REVERSE:** 2013-2015 1
series/MINI: Change
Rear Camera view
(60/40 split, etc)

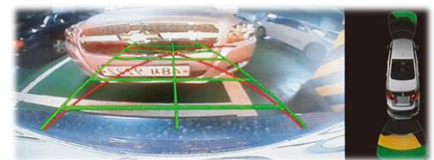

Agreement: End user agrees to use this product in compliance with all State and Federal laws. NAV-TV Corp. would not be held liable for misuse of its product. If you do not agree, please discontinue use immediately and return product to place of purchase. This product is intended for off-road use and passenger entertainment only.