

NAV-TV

INTERFACING THE FUTURE

BHM
10/16/18
NTV-DOC244

3950 NW 120th Ave, Coral Springs, FL 33065 TEL 561-955-9770 FAX 561-955-9760

www.nav-tv.com info@nav-tv.com

AUDI DYNAMIC-A3

NTV-KIT702



Quick Reference
(LVDS) Video Cable connects at MMI (inside glove box)
Power/CAN Harness connects at MMI (drop glovebox)
Unit requires 12v ACC power, NOT Constant 12v
Do not power camera with reverse light. Use ACC or purple wire (through relay)

Overview

The AUDI DYNAMIC-A3 Kit interfaces a backup camera input (with active parking lines) and 1 additional video input (front cam, etc) to the factory media screen in the 2014+ Audi A3 or VW Golf 7. Installation is performed behind the MMI (inside glove box).

Kit Contents

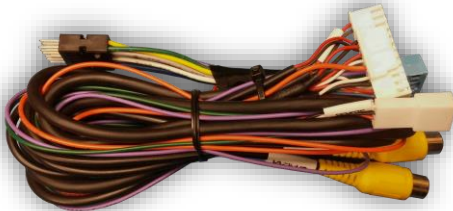

Power/CAN Harness



DYNAMIC-A3 Interface

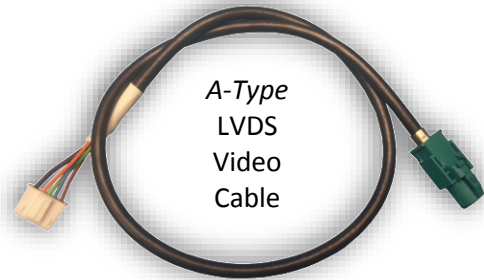

A-Type
LVDS
Video
Cable

HD-LINK Optional KIT800



Infrared Receiver



OSD Menu Remote

Agreement: End user agrees to use this product in compliance with all State and Federal laws. NAV-TV Corp. would not be held liable for misuse of its product. If you do not agree, please discontinue use immediately and return product to place of purchase. This product is intended for off-road use and passenger entertainment only.

Interface Connectors

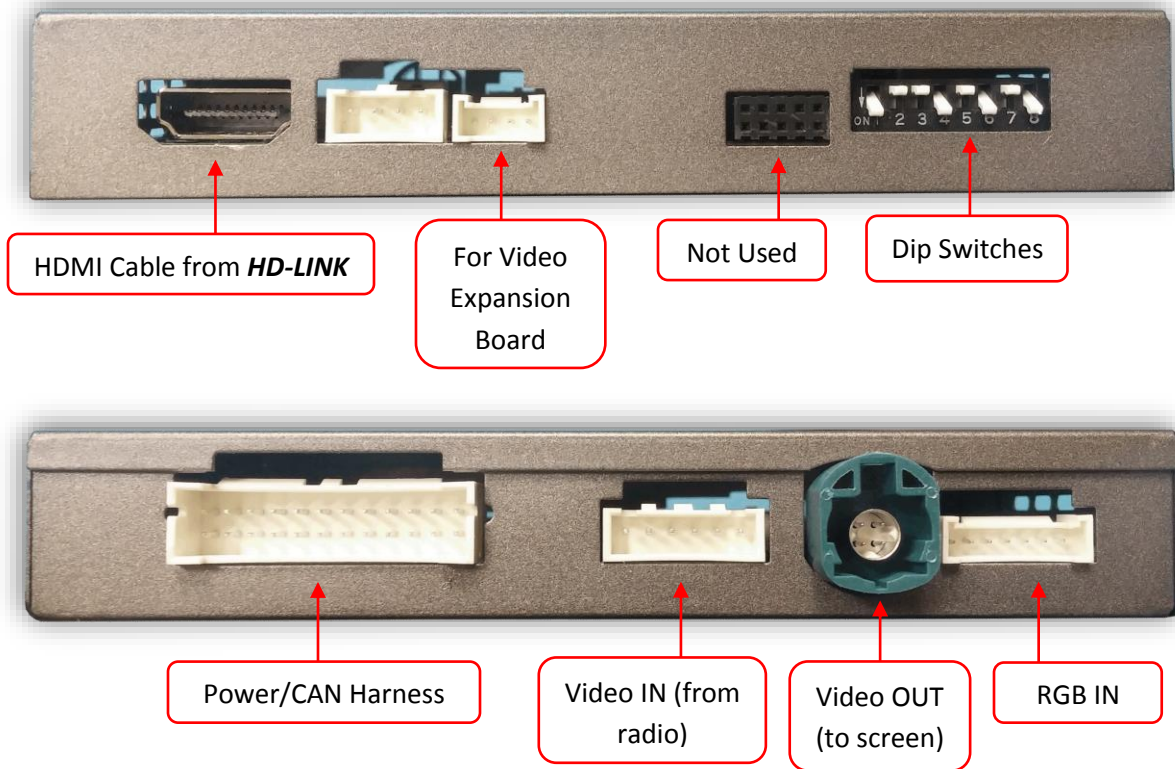

Dip Switch Settings

	---	AUX VID 1	AUX VID 2	RVC	TRANS*	iNAV button**	RES	---
Dip SW:	1	2	3	4	5	6	7	8
UP	Keep UP	OFF	OFF	OFF	AUTO	OFF	HIGH	Keep DOWN
DOWN	Keep UP	ON	ON	ON	MANUAL	ON	LOW	Keep DOWN

Note: Remove power to the unit prior to making adjustments to the dip switches

Note: Dip Switches 1 & 8 must be left in the position indicated above for proper operation

****iNAV button:** Activates AUX Video (optional)



Agreement: End user agrees to use this product in compliance with all State and Federal laws. NAV-TV Corp. would not be held liable for misuse of its product. If you do not agree, please discontinue use immediately and return product to place of purchase. This product is intended for off-road use and passenger entertainment only.

Installation (A3)

1. With European radio keys, remove the MMI located in glove box. Disconnect any associated harnesses and set the radio aside.
2. Grab the provided **'Power/CAN Harness'** from the DYNAMIC A3 kit. Connect the following wires to the *car*:

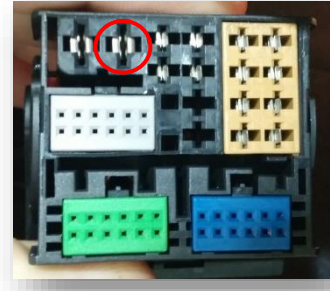

Interface wires	Connect to car	Location
Black (Ground)	Chassis Ground	PIN 15 (Radio plug)
Red (ACC 12v)	ACC 12v (+)	Blue/Yellow (cig lighter or drivers fuse box)
Green (Rev 12v in)*	Reverse Lamp (+)	---

***Note: this Green wire is ONLY used if CAN connection does not switch display to reverse properly.**

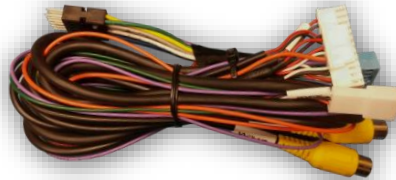

3. Locate the factory **Pink (For AUDI's with NAV, this connector is GRAY)**, 4-pin round connector that was removed from the radio in step 1. Connect this factory plug to the A3 interface at the port labeled **'VIDEO OUT'.***



***NOTE: You may need to shave some keyways on the factory connector in order for it to fit into the VIDEO-OUT connector.**

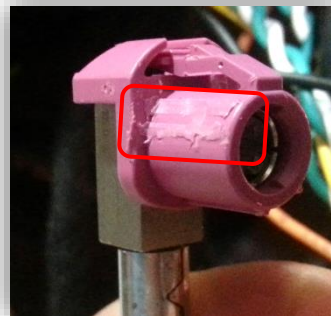

4. Connect the smaller white plug side of the provided **LVDS Video Cable** to the port on the A3 interface labeled **'VIDEO-IN'.**



Agreement: End user agrees to use this product in compliance with all State and Federal laws. NAV-TV Corp. would not be held liable for misuse of its product. If you do not agree, please discontinue use immediately and return product to place of purchase. This product is intended for off-road use and passenger entertainment only.

5. Connect the free end of the provided **LVDS Video Cable** (green) back to the factory radio at the appropriate port.
6. Connect the provided 12-pin plug & play portion from the main power harness to the main factory MMI connector as shown below. Pay attention to the orientation, as this is vital to proper operation:

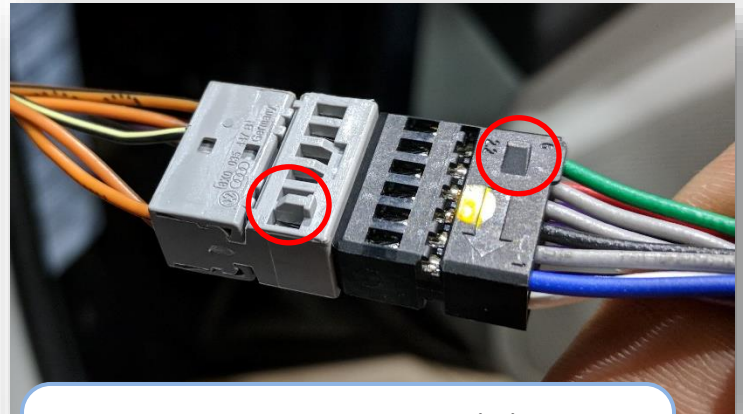

Connect the female 12-pin side of the plug & play portion to the OEM main MMI connector as shown. **NOTE: the paint dot must face towards the power wires.**

If the connector does not secure properly, zip tie the harness in place to surrounding wires **leaving slack so that the connector stays in place.** Use a spot of glue on the back side if you're still concerned with this.

Note: it may be easier to connect the main plug back to the MMI first and then connect this 12-pin through the quad-lock.

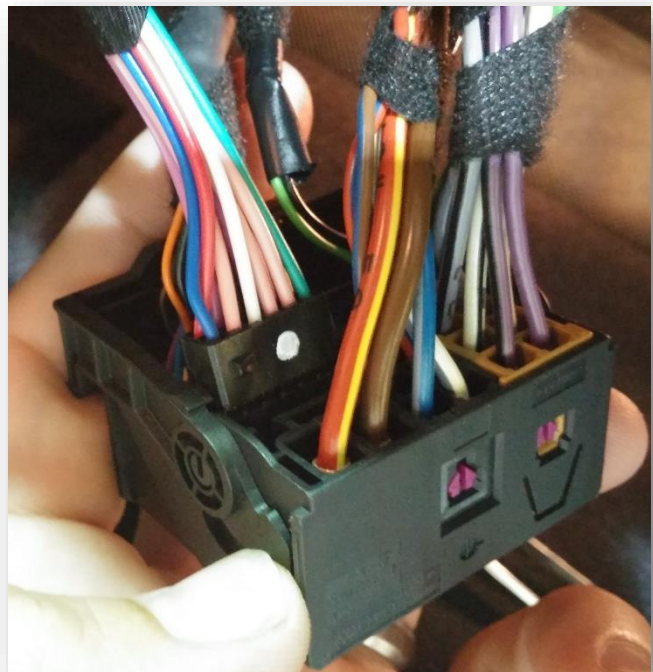

7. Connect ground and power for your camera, you may use the provided **purple** wire (labeled 'REAR12VOUT') for power for convenience. **NOTE:** *This power source will only supply 12v when the vehicle is in reverse (if forced rear camera is desired at any time, you'll need to use an ACC source for power instead).*
8. Connect the video feed from the camera to the RCA among the main power harness labeled 'CAMERA'.
9. Connect the white plug from the **Power/CAN Harness** to the port on the DYNAMIC A3 interface labeled 'POWER CAN'.
10. **Optional:** If adding an additional video input (including front camera), connect the video signal to the RCA among the Power/CAN Harness labeled 'CVBSIN'.
11. Start the car and test for proper functionality before replacing any dash pieces.
12. **If the screen does not transition to reverse image when in reverse, connect the *Green wire labeled 'REVERSE' to an OEM reverse lamp 12v (+) wire. This is sometimes the case with manual transmission-equipped vehicles.***

A3 Controls (MMI knob)

Press NAV to activate AUX Video Input (cycles through front cam and HDMI if added)

Note: This feature will only function when active (see OSD Menu settings pg 7)



DYNAMIC-A3 Basic Install Diagram

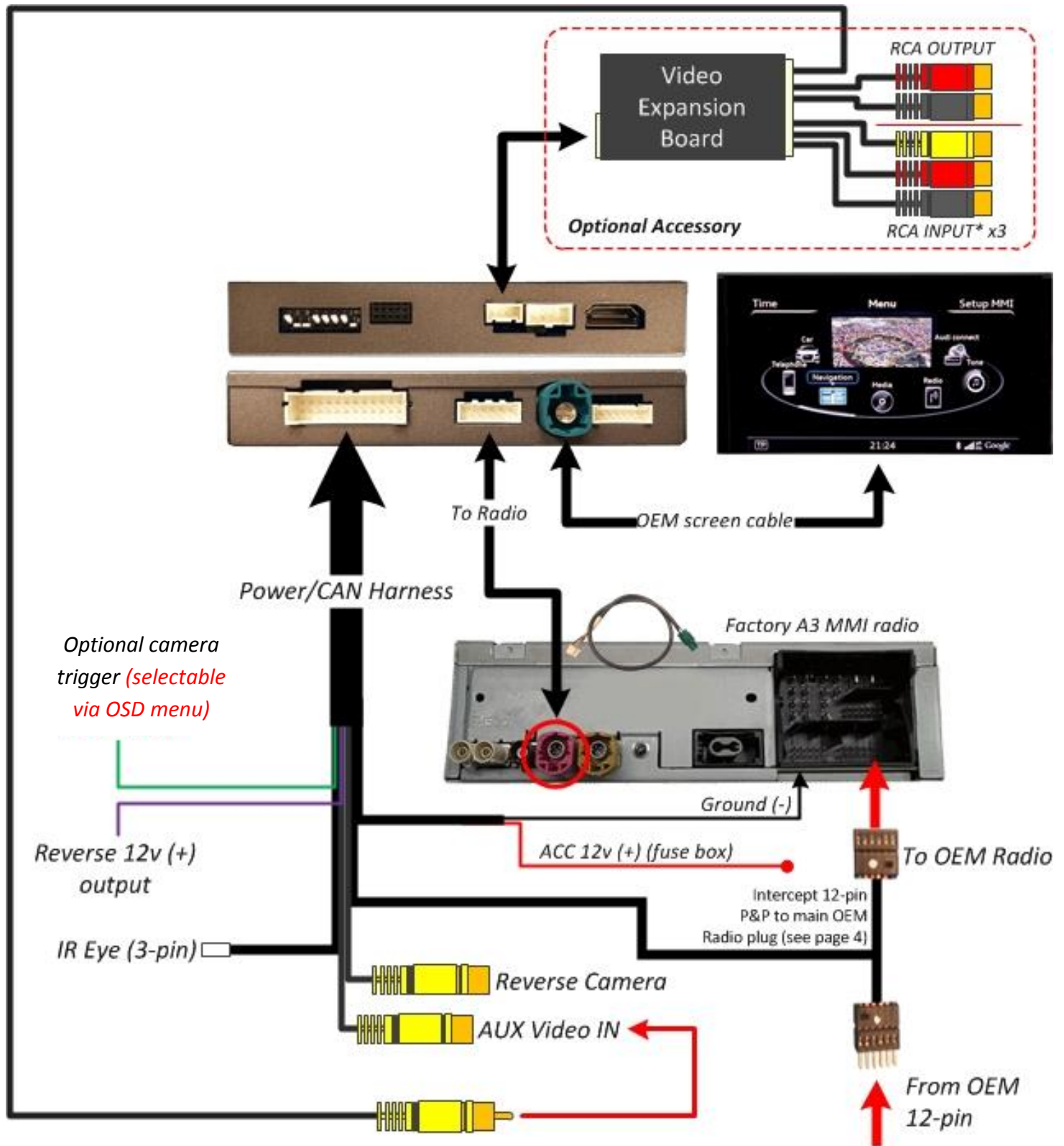

Agreement: End user agrees to use this product in compliance with all State and Federal laws. NAV-TV Corp. would not be held liable for misuse of its product. If you do not agree, please discontinue use immediately and return product to place of purchase. This product is intended for off-road use and passenger entertainment only.

Menu Adjustments

Before you start:

- The IR-Eye must be connected
- Make sure the car's ignition is on and radio is on
- You must be in **Reverse Camera** mode **OR** **AUX Video** mode (see below):
 - **Reverse Camera Mode** adjusts Reverse Camera Settings
 - **AUX Video Mode** adjusts AUX Video Settings
- Press the **OK BUTTON** 4 times (numbers will display per press), then press **POWER**.
- The **OSD Menu** will appear on screen (auto-time out in about 5 seconds if no action occurs).



Return
(AUX VID
menu
control)

RVC Menu

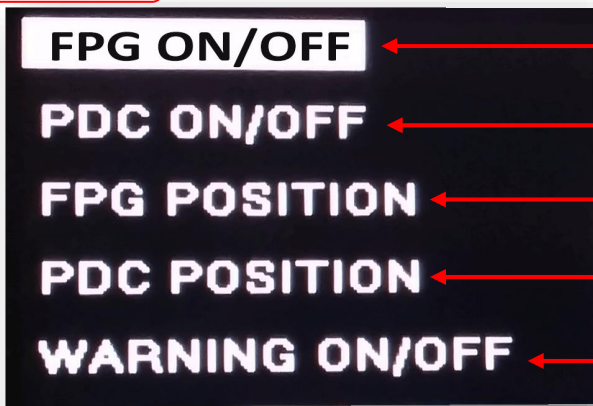

Functional Parking Guidelines ON/OFF

Parking Distance Control
ON/OFF (while in reverse)

Adjust FPG Position

Adjust PDC Position

'Safe to move?' ON/OFF

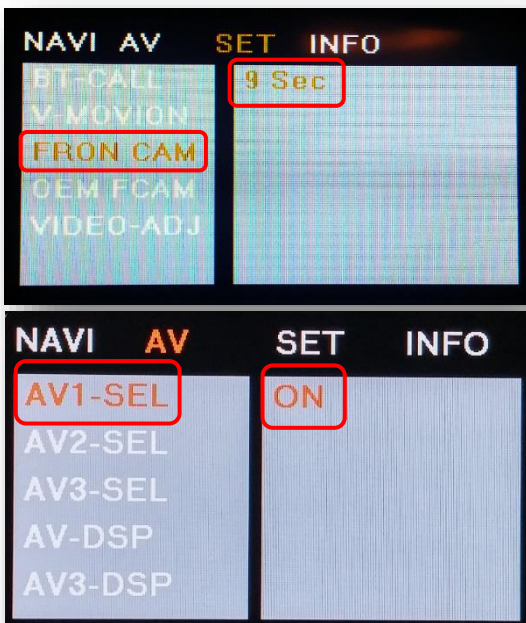
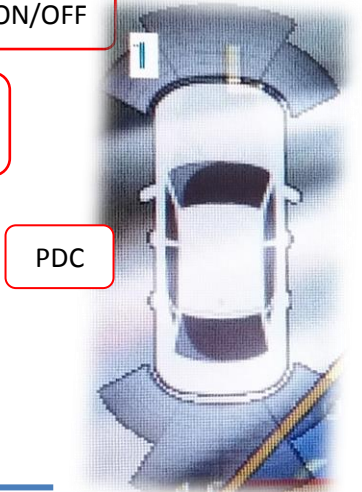

AUX
VIDEO
Menu

If adding a front camera OR Aux Video source:

1. Disconnect POWER/CAN Harness from interface
2. Place DIP SWITCH 1 in the DOWN position, reconnect power
3. Press the **NAV** button on the dash to activate 'NAV input'
4. Press **OK** button on remote 4 times, then press **POWER**

SET – FRON CAM must be turned on if adding a *front camera* **and the user wishes for automatic front camera switching**. Options for 5, 7, 9 or 11 seconds are user-selectable for the length of time the front camera input stays active once the vehicle is placed out of reverse.

If the user wants only an AUX video input **without front camera**, set **AV1-SEL** to **ON**

Once finished with settings, place DIP SWITCH 1 back into the **UP position** and reset power to interface.

Agreement: End user agrees to use this product in compliance with all State and Federal laws. NAV-TV Corp. would not be held liable for misuse of its product. If you do not agree, please discontinue use immediately and return product to place of purchase. This product is intended for off-road use and passenger entertainment only.

Adding HD-LINK Adapter (HDMI Input)

Follow the instructions below when adding the HDMI adapter (HD-LINK) to enable HDMI input to the OEM screen:



1. Put dip switch #1 in the **DOWN** position.
2. Activate the 'NAV INPUT' by pressing the 'NAV' button on the dashboard.
3. Once 'NAV INPUT' shows on the screen, on the remote press the **OK BUTTON 4 times**, then press **POWER**.
4. Navigate to the 'NAVI' section.
 - a. Select 'HDMI-SEL'
 - b. Choose 'HD95E'
 - c. Press **MODE** on the remote to return and exit the OSD menu (or let it time out).
5. Replace dip switch #1 to the **UP** position.
6. Connect the **black wire** to ground (-) and the **red wire** to ACC power (+) from the main power connector on the HD-LINK adapter. The RCA's on this plug provide audio from the HDMI source.

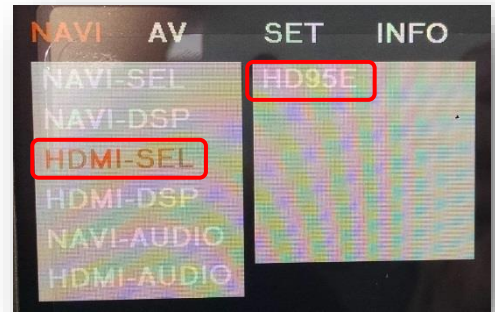

Green Trigger wire setup

This module includes a green *input* wire for analog triggering of either the Reverse camera input or the 'AVIN' input (yellow RCAs), selectable through the AV menu. This allows for adding multiple cameras through the use of an SVS-6 switcher, etc. Follow the steps below adjust this feature. **NOTE: by default, the green wire will trigger the Reverse camera input RCA.**

1. Put dip switch #1 in the **DOWN** position. When this section is complete, return switch #1 **UP**.
2. Activate the 'NAV INPUT' by pressing the 'NAV' button on the dashboard.
3. Once 'NAV INPUT' shows on the screen, on the remote press the **OK BUTTON 4 times**, then press **POWER**.
4. Navigate to the 'SET' section.
 - o Select 'REVERSE WIRE'
 - o Choose 'AV1', 'REAR' or 'REAR MODE' (explanations below)
 - o Press **MODE** on the remote to return and exit the OSD menu (or let it time out).
 - o Test by sending temporary power (12v +) to the **green wire** labeled reverse.

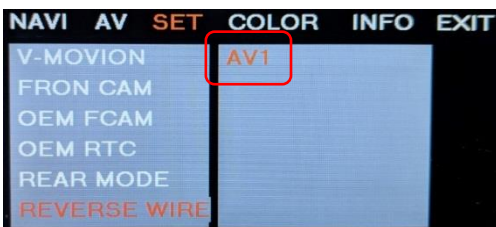

AV1 shows the 'AVIN' RCA when the green reverse wire is triggered.



REAR shows the 'CAMERA' RCA (with no lines) when the green reverse wire is triggered.

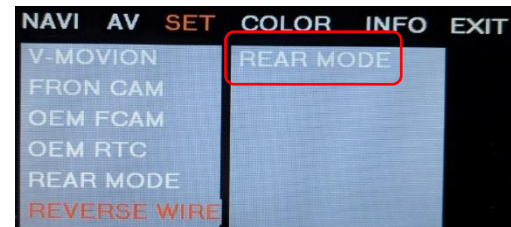

REAR MODE shows the 'CAMERA' RCA (with dynamic lines) when the green reverse wire is triggered.

Agreement: End user agrees to use this product for off-road use and passenger entertainment only. This product is not intended for use as a primary source of entertainment. The user agrees to be responsible for any misuse of its product. If you do not agree, please discontinue use immediately and return product to place of purchase. This product is intended for off-road use and passenger entertainment only.